

CLIQUE AQUI



ENG



ESP

aliancametalurgica.com.br



Catálogo de Produtos

- Fechaduras Digitais
- Fechaduras
- Ferragens
- Rodízios
- Reguladores para gás
- Válvulas de Esfera

ALIANÇA
Desde 1927

FECHADURAS

Fechadura Biométrica Iris Madeira.....	04
Fechadura Biométrica Iris Vidro	04
Fechadura Biométrica Titan	04
Ultra Line	05
Quadratta Curva	07
Quadratta Reta	10
Orion Anatomic.....	11
Elegance	12
Home	13
Home Elegance	13
Inox Classic	14
Colonial	14
Onda	16
Maxx	16
Galaxy	17
Vega	18
Taco de Golf	18
Pop	18
Joy	19
Quadratta Premium	20
Inox Premium	20
Fechadura Rolete	20
Fechaduras de Portão	22
Serralheiro	23
Travas de segurança	25

COMPONENTES

Máquinas	28
Componentes	29
Componente encartelados	32

FERRAGENS

Ferragens	36
Dobradiças	41
Cadeados	43
Ferragens Encartelados	44

RODÍZIOS

Rodízios	52
----------------	----

REGULADORES PARA GÁS

Linha Doméstica	54
Linha Semi Industrial	57
Linha Industrial	58
Conexões e Acessórios	64
Válvulas de Esfera para gás	65
Válvulas de Esfera para água	66
Descritivos Reguladores	67

Fechaduras



Linhas

- Digitais
- Quadratta
- Elegance
- Inox Classic
- Onda
- Quadratta Premium
- Taco de Golf
- Inox Premium
- Home
- Ultra Line
- Colonial
- Maxx
- Joy
- Vega
- Pop
- Galaxy
- Rolete
- Orion Anatômico

FICHAS TÉCNICAS FECHADURAS

Utilize o leitor de QR Code para
acessar as fichas técnicas
o ou **CLIQUE AQUI**





Fechaduras Digitais Aliança

A Aliança apresenta uma linha de fechaduras digitais com benefícios e vantagens a preços acessíveis. Produtos com solução de alto nível de segurança, a linha de fechaduras digitais Aliança garante praticidade e design para ambientes internos, oferecendo tecnologia e conectividade para uma rotina prática e funcional.



Imagens meramente ilustrativas

PRATICIDADE



Modelo indicado para porta de Madeira



SEGURANÇA



Modelo indicado para porta de vidro



TECNOLOGIA



Escolha o modelo mais indicado para sua casa

LANÇAMENTOS

Fechadura Digital Biométrica Iris

ACABAMENTO	MODELO	INDICADO
PF- Preto Fosco	Sobrepor	Porta de madeira



- Tag de Acesso Até 1.000
- App Integrado Bluetooth Tuya (consulte modelo)
- Leitor Biométrico Até 60 cadastros
- Senha numérica 6 dígitos

EMB. INDIV.	01
EMB. COLET.	-

APLICAÇÃO	REF.	CÓDIGO
EXTERNA	IRIS	087753

LANÇAMENTOS

Fechadura Digital Biométrica Iris

ACABAMENTO	MODELO	INDICADO
PF- Preto Fosco	Sobrepor	Porta de vidro



- Tag de Acesso Até 1.000
- App Integrado Bluetooth Tuya (consulte modelo)
- Leitor Biométrico Até 60 cadastros
- Senha numérica 6 dígitos

EMB. INDIV.	01
EMB. COLET.	-

APLICAÇÃO	REF.	CÓDIGO
EXTERNA	IRIS	087760

LANÇAMENTOS

Fechadura Digital Biométrica Titan

ACABAMENTO	MODELO	INDICADO
BP -Black Piano	Embutir	Porta de madeira



- Tag de Acesso Até 100
- Conexão Wi-Fi
- App Integrado (Tuya) (consulte modelo)
- Leitor Biométrico Até 100 cadastros
- Senha numérica 6 dígitos até 100 cadastros

EMB. INDIV.	01
EMB. COLET.	-

APLICAÇÃO	REF.	CÓDIGO
EXTERNA	TITAN	087784

Ultra Line S40mm Espelho

ACABAMENTO	CILINDRO	MÁQUINA
BL- BRONZE LATONADO	C-700 - 56mm	S40mm



EMB. INDIV.	01
EMB. COLET.	04

APLICAÇÃO	REF.	CÓDIGO
EXTERNA	4411	078683
INTERNA	4412	078690
BANHO	4413	078706

AÇO / AÇO INOX / ZAMAC

Ultra Line S40mm Espelho

ACABAMENTO	CILINDRO	MÁQUINA
CR- CROMADO	C-700 - 56mm	S40mm



EMB. INDIV.	01
EMB. COLET.	04

APLICAÇÃO	REF.	CÓDIGO
EXTERNA	4411	078560
INTERNA	4412	078577
BANHO	4413	078584

AÇO / AÇO INOX / ZAMAC

Ultra Line 55mm Espelho

ACABAMENTO	CILINDRO	MÁQUINA
BL- BRONZE LATONADO	C-700 - 56mm	55mm



EMB. INDIV.	01
EMB. COLET.	04

APLICAÇÃO	REF.	CÓDIGO
EXTERNA	5411	078713
INTERNA	5412	078720
BANHO	5413	078737

AÇO / AÇO INOX / ZAMAC

Ultra Line 55mm Espelho

ACABAMENTO	CILINDRO	MÁQUINA
CR- CROMADO	C-700 - 56mm	55mm



EMB. INDIV.	01
EMB. COLET.	04

APLICAÇÃO	REF.	CÓDIGO
EXTERNA	5411	078621
INTERNA	5412	078638
BANHO	5413	078645

AÇO / AÇO INOX / ZAMAC

Ultra Line 55mm Espelho

ACABAMENTO	CILINDRO	MÁQUINA
PF- PRETO FOSCO	C-700 - 56mm	55mm



EMB. INDIV.	01
EMB. COLET.	04

APLICAÇÃO	REF.	CÓDIGO
EXTERNA	5411	082789
INTERNA	5412	082796
BANHO	5413	082802

AÇO / AÇO INOX / ZAMAC

Ultra Line S40mm Roseta

ACABAMENTO	CILINDRO	MÁQUINA
BL- BRONZE LATONADO	C-700 - 56mm	S40mm



EMB. INDIV.	01
EMB. COLET.	04

APLICAÇÃO	REF.	CÓDIGO
EXTERNA	4401	079277
INTERNA	4402	079284
BANHO	4403	079291

AÇO / AÇO INOX / ZAMAC

Ultra Line S40mm Roseta

ACABAMENTO	CILINDRO	MÁQUINA
CR- CROMADO	C-700 - 56mm	S40mm



EMB. INDIV.	01
EMB. COLET.	04

APLICAÇÃO	REF.	CÓDIGO
EXTERNA	4401	079406
INTERNA	4402	079413
BANHO	4403	079420

AÇO / AÇO INOX / ZAMAC

Ultra Line 55mm Roseta

ACABAMENTO	CILINDRO	MÁQUINA
BL- BRONZE LATONADO	C-700 - 56mm	55mm



EMB. INDIV.	01
EMB. COLET.	04

APLICAÇÃO	REF.	CÓDIGO
EXTERNA	5401	079239
INTERNA	5402	079246
BANHO	5403	079253

AÇO / AÇO INOX / ZAMAC

Ultra Line 55mm Roseta

ACABAMENTO	CILINDRO	MÁQUINA
CR- CROMADO	C-700 - 56mm	55mm



EMB. INDIV.	01
EMB. COLET.	04

APLICAÇÃO	REF.	CÓDIGO
EXTERNA	5401	079154
INTERNA	5402	079161
BANHO	5403	079178

AÇO / AÇO INOX / ZAMAC

Ultra Line 55mm Roseta

ACABAMENTO	CILINDRO	MÁQUINA
PF- PRETO FOSCO	C-700 - 56mm	55mm



EMB. INDIV.	01
EMB. COLET.	04

APLICAÇÃO	REF.	CÓDIGO
EXTERNA	5401	082659
INTERNA	5402	082666
BANHO	5403	082673

AÇO / AÇO INOX / ZAMAC

Ultra Line Tetra S40mm Espelho

ACABAMENTO	CILINDRO	MÁQUINA
BL- BRONZE LATONADO	C-1200 - 56mm	S40mm



EMB. INDIV.	01
EMB. COLET.	04

APLICAÇÃO	REF.	CÓDIGO
EXTERNA	4230	079857

AÇO INOX / ZAMAC / LATÃO

Ultra Line Tetra S40mm Espelho

ACABAMENTO	CILINDRO	MÁQUINA
CR- CROMADO	C-1200 - 56mm	S40mm



EMB. INDIV.	01
EMB. COLET.	04

APLICAÇÃO	REF.	CÓDIGO
EXTERNA	4230	079833

AÇO INOX / ZAMAC / LATÃO

Ultra Line 55mm Tetra Espelho

ACABAMENTO	CILINDRO	MÁQUINA
BL- BRONZE LATONADO	C-1200 - 56mm	55mm



EMB. INDIV.
01
EMB. COLET.
04

APLICAÇÃO	REF.	CÓDIGO
EXTERNA	5230	079673

AÇO INOX / ZAMAC / LATÃO

Ultra Line Tetra 55mm Espelho

ACABAMENTO	CILINDRO	MÁQUINA
CR- CROMADO	C-1200 - 56mm	55mm



EMB. INDIV.
01
EMB. COLET.
04

APLICAÇÃO	REF.	CÓDIGO
EXTERNA	5230	079659

AÇO INOX / ZAMAC / LATÃO

Ultra Line Tetra 55mm Espelho

ACABAMENTO	CILINDRO	MÁQUINA
CRE- CROM. ESCOVADO	C-1200 - 56mm	55mm



EMB. INDIV.
01
EMB. COLET.
04

APLICAÇÃO	REF.	CÓDIGO
EXTERNA	5230	079666

AÇO INOX / ZAMAC / LATÃO

Ultra Line Tetra S40mm Roseta

ACABAMENTO	CILINDRO	MÁQUINA
BL- BRONZE LATONADO	C-1200 - 56mm	S40mm



EMB. INDIV.
01
EMB. COLET.
04

APLICAÇÃO	REF.	CÓDIGO
EXTERNA	44020	079307

AÇO INOX / ZAMAC / LATÃO

Ultra Line Tetra S40mm Roseta

ACABAMENTO	CILINDRO	MÁQUINA
CR- CROMADO	C-1200 - 56mm	S40mm



EMB. INDIV.
01
EMB. COLET.
04

APLICAÇÃO	REF.	CÓDIGO
EXTERNA	44020	079437

AÇO INOX / ZAMAC / LATÃO

Ultra Line Tetra 55mm Roseta

ACABAMENTO	CILINDRO	MÁQUINA
BL- BRONZE LATONADO	C-1200 - 56mm	55mm



EMB. INDIV.
01
EMB. COLET.
04

APLICAÇÃO	REF.	CÓDIGO
EXTERNA	54020	079260

AÇO INOX / ZAMAC / LATÃO

Ultra Line Tetra 55mm Roseta

ACABAMENTO	CILINDRO	MÁQUINA
CR- CROMADO	C-1200 - 56mm	55mm



EMB. INDIV.
01
EMB. COLET.
04

APLICAÇÃO	REF.	CÓDIGO
EXTERNA	54020	079185

AÇO INOX / ZAMAC / LATÃO

Ultra Line Tetra 55mm Roseta

ACABAMENTO	CILINDRO	MÁQUINA
CRE- CROM. ESCOVADO	C-1200 - 56mm	55mm



EMB. INDIV.
01
EMB. COLET.
04

APLICAÇÃO	REF.	CÓDIGO
EXTERNA	54020	079222

AÇO INOX / ZAMAC / LATÃO

Ultra Line Kit Tetra 3X1 S40mm Espelho

ACABAMENTO	CILINDRO	MÁQUINA
BL- BRONZE LATONADO	C-1200 - 56mm	S40mm



EMB. INDIV.
01
EMB. COLET.
04

AÇO INOX
ZAMAC
LATÃO

APLICAÇÃO	REF.	CÓDIGO
EXTERNA	42030	079949

Ultra Line Kit Tetra 3X1 S40mm Espelho

ACABAMENTO	CILINDRO	MÁQUINA
CR- CROMADO	C-1200 - 56mm	S40mm



EMB. INDIV.
01
EMB. COLET.
04

AÇO INOX
ZAMAC
LATÃO

APLICAÇÃO	REF.	CÓDIGO
EXTERNA	42030	079925

Ultra Line Kit Tetra 3X1 55mm Espelho

ACABAMENTO	CILINDRO	MÁQUINA
BL- BRONZE LATONADO	C-1200 - 56mm	55mm



EMB. INDIV.
01
EMB. COLET.
04

AÇO INOX
ZAMAC
LATÃO

APLICAÇÃO	REF.	CÓDIGO
EXTERNA	55030	079765

Ultra Line Kit Tetra 3X1 55mm Espelho

ACABAMENTO	CILINDRO	MÁQUINA
CR- CROMADO	C-1200 - 56mm	55mm



EMB. INDIV.
01
EMB. COLET.
04

AÇO INOX
ZAMAC
LATÃO

APLICAÇÃO	REF.	CÓDIGO
EXTERNA	55030	079741

Ultra Line Kit Tetra 3X1 55mm Espelho

ACABAMENTO	CILINDRO	MÁQUINA
CRE- CROM. ESCOVADO	C-1200 - 56mm	55mm



EMB. INDIV.	01
EMB. COLET.	04

AÇO INOX
 ZAMAC
 LATÃO

APLICAÇÃO	REF.	CÓDIGO
EXTERNA	55030	079758

Ultra Line Kit Tetra 3X1 55mm Espelho

ACABAMENTO	CILINDRO	MÁQUINA
PF- PRETO FOSCO	C-1200 - 56mm	55mm



EMB. INDIV.	01
EMB. COLET.	04

AÇO INOX
 ZAMAC
 LATÃO

APLICAÇÃO	REF.	CÓDIGO
EXTERNA	55030	082758

Ultra Line Kit Tetra 3X1 S40mm Roseta

ACABAMENTO	CILINDRO	MÁQUINA
BL- BRONZE LATONADO	C-1200 - 56mm	S40mm



EMB. INDIV.	01
EMB. COLET.	04

AÇO INOX
 ZAMAC
 LATÃO

APLICAÇÃO	REF.	CÓDIGO
EXTERNA	42020	079529

Ultra Line Kit Tetra 3X1 S40mm Roseta

ACABAMENTO	CILINDRO	MÁQUINA
CR- CROMADO	C-1200 - 56mm	S40mm



EMB. INDIV.	01
EMB. COLET.	04

AÇO INOX
 ZAMAC
 LATÃO

APLICAÇÃO	REF.	CÓDIGO
EXTERNA	42020	079512

Ultra Line Kit Tetra 3X1 55mm Roseta

ACABAMENTO	CILINDRO	MÁQUINA
BL- BRONZE LATONADO	C-1200 - 56mm	55mm



EMB. INDIV.	01
EMB. COLET.	04

AÇO INOX
 ZAMAC
 LATÃO

APLICAÇÃO	REF.	CÓDIGO
EXTERNA	54020	079208

Ultra Line Kit Tetra 3X1 55mm Roseta

ACABAMENTO	CILINDRO	MÁQUINA
CR- CROMADO	C-1200 - 56mm	55mm



EMB. INDIV.	01
EMB. COLET.	04

AÇO INOX
 ZAMAC
 LATÃO

APLICAÇÃO	REF.	CÓDIGO
EXTERNA	54020	079192

Ultra Line Kit Tetra 3X1 55mm Roseta

ACABAMENTO	CILINDRO	MÁQUINA
CRE- CROM. ESCOVADO	C-1200 - 56mm	55mm



EMB. INDIV.	01
EMB. COLET.	04

AÇO INOX
 ZAMAC
 LATÃO

APLICAÇÃO	REF.	CÓDIGO
EXTERNA	54020	079215

Quadratta Curva S40mm Espelho

ACABAMENTO	CILINDRO	MÁQUINA
BL- BRONZE LATONADO	C-700 - 56mm	S40mm



EMB. INDIV.	01
EMB. COLET.	04

APLICAÇÃO	REF.	CÓDIGO
EXTERNA	4211	077792
INTERNA	4212	077808
BANHO	4213	077815

AÇO / AÇO INOX / ZAMAC

Quadratta Curva S40mm Espelho

ACABAMENTO	CILINDRO	MÁQUINA
CR- CROMADO	C-700 - 56mm	S40mm



EMB. INDIV.	01
EMB. COLET.	04

APLICAÇÃO	REF.	CÓDIGO
EXTERNA	4211	077679
INTERNA	4212	077686
BANHO	4213	077693

AÇO / AÇO INOX / ZAMAC

Quadratta Curva S40mm Espelho

ACABAMENTO	CILINDRO	MÁQUINA
CRE- CROM. ESCOVADO	C-700 - 56mm	S40mm



EMB. INDIV.	01
EMB. COLET.	04

APLICAÇÃO	REF.	CÓDIGO
EXTERNA	4211	077709
INTERNA	4212	077716
BANHO	4213	077723

AÇO / AÇO INOX / ZAMAC

Quadratta Curva S40mm Espelho

ACABAMENTO	CILINDRO	MÁQUINA
PF- PRETO FOSCO	C-700 - 56mm	S40mm



EMB. INDIV.	01
EMB. COLET.	04

APLICAÇÃO	REF.	CÓDIGO
EXTERNA	4211	082598
INTERNA	4212	082604
BANHO	4213	082611

AÇO / AÇO INOX / ZAMAC

Quadratta Curva 55mm Espelho

ACABAMENTO	CILINDRO	MÁQUINA
BL- BRONZE LATONADO	C-700 - 56mm	55mm



EMB. INDIV.	01
EMB. COLET.	04

APLICAÇÃO	REF.	CÓDIGO
EXTERNA	5211	077822
INTERNA	5212	077839
BANHO	5213	077846

AÇO / AÇO INOX / ZAMAC

Quadratta Curva 55mm Espelho

ACABAMENTO	CILINDRO	MÁQUINA
CR- CROMADO	C-700 - 56mm	55mm



EMB. INDIV.	01
EMB. COLET.	04

APLICAÇÃO	REF.	CÓDIGO
EXTERNA	5211	077730
INTERNA	5212	077747
BANHO	5213	077754

AÇO / AÇO INOX / ZAMAC

Quadratta Curva S40mm Roseta

ACABAMENTO	CILINDRO	MÁQUINA
BL- BRONZE LATONADO	C-700 - 56mm	S40mm



EMB. INDIV.	01
EMB. COLET.	04

APLICAÇÃO	REF.	CÓDIGO
EXTERNA	4201	074319
INTERNA	4202	074326
BANHO	4203	074333

AÇO / AÇO INOX / ZAMAC

Quadratta Curva S40mm Roseta

ACABAMENTO	CILINDRO	MÁQUINA
CR- CROMADO	C-700 - 56mm	S40mm



EMB. INDIV.	01
EMB. COLET.	04

APLICAÇÃO	REF.	CÓDIGO
EXTERNA	4201	074258
INTERNA	4202	074265
BANHO	4203	074272

AÇO / AÇO INOX / ZAMAC

Quadratta Curva S40mm Roseta

ACABAMENTO	CILINDRO	MÁQUINA
CRE- CROM. ESCOVADO	C-700 - 56mm	S40mm



EMB. INDIV.	01
EMB. COLET.	04

APLICAÇÃO	REF.	CÓDIGO
EXTERNA	4201	074289
INTERNA	4202	074296
BANHO	4203	074302

AÇO / AÇO INOX / ZAMAC

Quadratta Curva S40mm Roseta

ACABAMENTO	CILINDRO	MÁQUINA
PF- PRETO FOSCO	C-700 - 56mm	S40mm



EMB. INDIV.	01
EMB. COLET.	04

APLICAÇÃO	REF.	CÓDIGO
EXTERNA	4201	082628
INTERNA	4202	082635
BANHO	4203	082642

AÇO / AÇO INOX / ZAMAC

Quadratta Curva 55mm Roseta

ACABAMENTO	CILINDRO	MÁQUINA
BL- BRONZE LATONADO	C-700 - 56mm	55mm



EMB. INDIV.	01
EMB. COLET.	04

APLICAÇÃO	REF.	CÓDIGO
EXTERNA	5201	074432
INTERNA	5202	074449
BANHO	5203	074456

AÇO / AÇO INOX / ZAMAC

Quadratta Curva 55mm Roseta

ACABAMENTO	CILINDRO	MÁQUINA
CR- CROMADO	C-700 - 56mm	55mm



EMB. INDIV.	01
EMB. COLET.	04

APLICAÇÃO	REF.	CÓDIGO
EXTERNA	5201	074371
INTERNA	5202	074388
BANHO	5203	074395

AÇO / AÇO INOX / ZAMAC

Quadratta Curva Tetra S40mm Espelho

ACABAMENTO	CILINDRO	MÁQUINA
BL- BRONZE LATONADO	C-1200 - 56mm	S40mm



EMB. INDIV.	01
EMB. COLET.	04

APLICAÇÃO	REF.	CÓDIGO
EXTERNA	4210	079796

AÇO INOX / ZAMAC / LATÃO

Quadratta Curva Tetra S40mm Espelho

ACABAMENTO	CILINDRO	MÁQUINA
CR- CROMADO	C-1200 - 56mm	S40mm



EMB. INDIV.	01
EMB. COLET.	04

APLICAÇÃO	REF.	CÓDIGO
EXTERNA	4210	079772

AÇO INOX / ZAMAC / LATÃO

Quadratta Curva Tetra 55mm Espelho

ACABAMENTO	CILINDRO	MÁQUINA
BL- BRONZE LATONADO	C-1200 - 56mm	55mm



EMB. INDIV.	01
EMB. COLET.	04

APLICAÇÃO	REF.	CÓDIGO
EXTERNA	5210	079611

AÇO INOX / ZAMAC / LATÃO

Quadratta Curva Tetra 55mm Espelho

ACABAMENTO	CILINDRO	MÁQUINA
CR- CROMADO	C-1200 - 56mm	55mm



EMB. INDIV.
01
EMB. COLET.
04

APLICAÇÃO	REF.	CÓDIGO
EXTERNA	5210	079598

AÇO INOX / ZAMAC / LATÃO

Quadratta Curva Tetra 55mm Roseta

ACABAMENTO	CILINDRO	MÁQUINA
BL- BRONZE LATONADO	C-1200 - 56mm	55mm



EMB. INDIV.
01
EMB. COLET.
04

APLICAÇÃO	REF.	CÓDIGO
EXTERNA	55520	076771

AÇO INOX / ZAMAC / LATÃO

Quadratta Curva Tetra 55mm Roseta

ACABAMENTO	CILINDRO	MÁQUINA
CR- CROMADO	C-1200 - 56mm	55mm



EMB. INDIV.
01
EMB. COLET.
04

APLICAÇÃO	REF.	CÓDIGO
EXTERNA	55520	076764

AÇO INOX / ZAMAC / LATÃO

Quadratta Curva Kit Tetra 3X1 S40mm Espelho

ACABAMENTO	CILINDRO	MÁQUINA
BL- BRONZE LATONADO	C-1200 - 56mm	S40mm



EMB. INDIV.
01
EMB. COLET.
04

AÇO INOX
ZAMAC
LATÃO

APLICAÇÃO	REF.	CÓDIGO
EXTERNA	42010	079888

Quadratta Curva Kit Tetra 3X1 S40mm Espelho

ACABAMENTO	CILINDRO	MÁQUINA
CR- CROMADO	C-1200 - 56mm	S40mm



EMB. INDIV.
01
EMB. COLET.
04

AÇO INOX
ZAMAC
LATÃO

APLICAÇÃO	REF.	CÓDIGO
EXTERNA	42010	079864

Quadratta Curva Kit Tetra 3X1 S40mm Espelho

ACABAMENTO	CILINDRO	MÁQUINA
CRE- CROM. ESCOVADO	C-1200 - 56mm	S40mm



EMB. INDIV.
01
EMB. COLET.
04

AÇO INOX
ZAMAC
LATÃO

APLICAÇÃO	REF.	CÓDIGO
EXTERNA	42010	079871

Quadratta Curva Kit Tetra 3X1 S40mm Espelho

ACABAMENTO	CILINDRO	MÁQUINA
PF- PRETO FOSCO	C-1200 - 56mm	S40mm



EMB. INDIV.
01
EMB. COLET.
04

AÇO INOX
ZAMAC
LATÃO

APLICAÇÃO	REF.	CÓDIGO
EXTERNA	42010	082741

Quadratta Curva Kit Tetra 3X1 55mm Espelho

ACABAMENTO	CILINDRO	MÁQUINA
BL- BRONZE LATONADO	C-1200 - 56mm	55mm



EMB. INDIV.
01
EMB. COLET.
04

AÇO INOX
ZAMAC
LATÃO

APLICAÇÃO	REF.	CÓDIGO
EXTERNA	55010	079703

Quadratta Curva Kit Tetra 3X1 55mm Espelho

ACABAMENTO	CILINDRO	MÁQUINA
CR- CROMADO	C-1200 - 56mm	55mm



EMB. INDIV.
01
EMB. COLET.
04

AÇO INOX
ZAMAC
LATÃO

APLICAÇÃO	REF.	CÓDIGO
EXTERNA	55010	079680

Quadratta Curva Kit Tetra 3X1 55mm Roseta

ACABAMENTO	CILINDRO	MÁQUINA
BL- BRONZE LATONADO	C-1200 - 56mm	55mm



EMB. INDIV.
01
EMB. COLET.
04

AÇO INOX
ZAMAC
LATÃO

APLICAÇÃO	REF.	CÓDIGO
EXTERNA	55520-T	076795

Quadratta Curva Kit Tetra 3X1 55mm Roseta

ACABAMENTO	CILINDRO	MÁQUINA
CR- CROMADO	C-1200 - 56mm	55mm



EMB. INDIV.
01
EMB. COLET.
04

AÇO INOX
ZAMAC
LATÃO

APLICAÇÃO	REF.	CÓDIGO
EXTERNA	55520-T	076788

Quadratta Reta S40mm Espelho

ACABAMENTO	CILINDRO	MÁQUINA
BL- BRONZE LATONADO	C-700 - 56mm	S40mm



EMB. INDIV.
01

EMB. COLET.
04

APLICAÇÃO	REF.	CÓDIGO
EXTERNA	4311	077976
INTERNA	4312	077983
BANHO	4313	077990

AÇO / AÇO INOX / ZAMAC

Quadratta Reta S40mm Espelho

ACABAMENTO	CILINDRO	MÁQUINA
CR- CROMADO	C-700 - 56mm	S40mm



EMB. INDIV.
01

EMB. COLET.
04

APLICAÇÃO	REF.	CÓDIGO
EXTERNA	4311	077853
INTERNA	4312	077860
BANHO	4313	077877

AÇO / AÇO INOX / ZAMAC

Quadratta Reta 55mm Espelho

ACABAMENTO	CILINDRO	MÁQUINA
BL- BRONZE LATONADO	C-700 - 56mm	55mm



EMB. INDIV.
01

EMB. COLET.
04

APLICAÇÃO	REF.	CÓDIGO
EXTERNA	5311	078003
INTERNA	5312	078010
BANHO	5313	078027

AÇO / AÇO INOX / ZAMAC

Quadratta Reta 55mm Espelho

ACABAMENTO	CILINDRO	MÁQUINA
CR- CROMADO	C-700 - 56mm	55mm



EMB. INDIV.
01

EMB. COLET.
04

APLICAÇÃO	REF.	CÓDIGO
EXTERNA	5311	077914
INTERNA	5312	077921
BANHO	5313	077938

AÇO / AÇO INOX / ZAMAC

Quadratta Reta S40mm Roseta

ACABAMENTO	CILINDRO	MÁQUINA
BL- BRONZE LATONADO	C-700 - 56mm	S40mm



EMB. INDIV.
01

EMB. COLET.
04

APLICAÇÃO	REF.	CÓDIGO
EXTERNA	4301	075071
INTERNA	4302	075088
BANHO	4303	075095

AÇO / AÇO INOX / ZAMAC

Quadratta Reta S40mm Roseta

ACABAMENTO	CILINDRO	MÁQUINA
CR- CROMADO	C-700 - 56mm	S40mm



EMB. INDIV.
01

EMB. COLET.
04

APLICAÇÃO	REF.	CÓDIGO
EXTERNA	4301	075118
INTERNA	4302	075125
BANHO	4303	075132

AÇO / AÇO INOX / ZAMAC

Quadratta Reta S40mm Roseta

ACABAMENTO	CILINDRO	MÁQUINA
PF- PRETO FOSCO	C-700 - 56mm	S40mm



EMB. INDIV.
01

EMB. COLET.
04

APLICAÇÃO	REF.	CÓDIGO
EXTERNA	4301	082840
INTERNA	4302	082857
BANHO	4303	082864

AÇO / AÇO INOX / ZAMAC

Quadratta Reta 55mm Roseta

ACABAMENTO	CILINDRO	MÁQUINA
BL- BRONZE LATONADO	C-700 - 56mm	55mm



EMB. INDIV.
01

EMB. COLET.
04

APLICAÇÃO	REF.	CÓDIGO
EXTERNA	5301	075231
INTERNA	5302	075248
BANHO	5303	075255

AÇO / AÇO INOX / ZAMAC

Quadratta Reta 55mm Roseta

ACABAMENTO	CILINDRO	MÁQUINA
CR- CROMADO	C-700 - 56mm	55mm



EMB. INDIV.
01

EMB. COLET.
04

APLICAÇÃO	REF.	CÓDIGO
EXTERNA	5301	075279
INTERNA	5302	075286
BANHO	5303	075293

AÇO / AÇO INOX / ZAMAC

Quadratta Reta Tetra S40mm Espelho

ACABAMENTO	CILINDRO	MÁQUINA
BL- BRONZE LATONADO	C-1200 - 56mm	S40mm



EMB. INDIV.
01

EMB. COLET.
04

APLICAÇÃO	REF.	CÓDIGO
EXTERNA	4220	079826

AÇO INOX / ZAMAC / LATÃO

Quadratta Reta Tetra S40mm Espelho

ACABAMENTO	CILINDRO	MÁQUINA
CR- CROMADO	C-1200 - 56mm	S40mm



EMB. INDIV.
01

EMB. COLET.
04

APLICAÇÃO	REF.	CÓDIGO
EXTERNA	4220	079802

AÇO INOX / ZAMAC / LATÃO

Quadratta Reta Tetra 55mm Espelho

ACABAMENTO	CILINDRO	MÁQUINA
BL- BRONZE LATONADO	C-1200 - 56mm	55mm



EMB. INDIV.
01

EMB. COLET.
04

APLICAÇÃO	REF.	CÓDIGO
EXTERNA	5220	079642

AÇO INOX / ZAMAC / LATÃO

Quadratta Reta Tetra 55mm Espelho

ACABAMENTO	CILINDRO	MÁQUINA
CR- CROMADO	C-1200 - 56mm	55mm



EMB. INDIV.
01

EMB. COLET.
04

APLICAÇÃO	REF.	CÓDIGO
EXTERNA	5220	079628

ÁÇO INOX / ZAMAC / LATÃO

Quadratta Reta Kit Tetra 3X1 S40mm Espelho

ACABAMENTO	CILINDRO	MÁQUINA
BL- BROZE LATONADO	C-1200 - 56mm	S40mm



EMB. INDIV.
01

EMB. COLET.
04

APLICAÇÃO	REF.	CÓDIGO
EXTERNA	42020	079918

ÁÇO INOX
ZAMAC
LATÃO

Quadratta Reta Kit Tetra 3X1 S40mm Espelho

ACABAMENTO	CILINDRO	MÁQUINA
CR- CROMADO	C-1200 - 56mm	S40mm



EMB. INDIV.
01

EMB. COLET.
04

APLICAÇÃO	REF.	CÓDIGO
EXTERNA	42020	079895

ÁÇO INOX
ZAMAC
LATÃO

Quadratta Reta Kit Tetra 3X1 55mm Espelho

ACABAMENTO	CILINDRO	MÁQUINA
BL- BROZE LATONADO	C-1200 - 56mm	55mm



EMB. INDIV.
01

EMB. COLET.
04

APLICAÇÃO	REF.	CÓDIGO
EXTERNA	55020	079734

ÁÇO INOX
ZAMAC
LATÃO

Quadratta Reta Kit Tetra 3X1 55mm Espelho

ACABAMENTO	CILINDRO	MÁQUINA
CR- CROMADO	C-1200 - 56mm	55mm



EMB. INDIV.
01

EMB. COLET.
04

APLICAÇÃO	REF.	CÓDIGO
EXTERNA	55020	079710

ÁÇO INOX
ZAMAC
LATÃO

Orion Anatomic 55mm Espelho

ACABAMENTO	CILINDRO	MÁQUINA
BL- BRONZE LATONADO	C-700 - 56mm	55mm



EMB. INDIV.
01

EMB. COLET.
04

APLICAÇÃO	REF.	CÓDIGO
EXTERNA	5561AZ	056933
INTERNA	5562AZ	060053
BANHO	5563AZ	060060

ÁÇO / ÁÇO INOX / ZAMAC

Orion Anatomic 55mm Espelho

ACABAMENTO	CILINDRO	MÁQUINA
CR- CROMADO	C-700 - 56mm	55mm



EMB. INDIV.
01

EMB. COLET.
04

APLICAÇÃO	REF.	CÓDIGO
EXTERNA	5561AZ	056957
INTERNA	5562AZ	060930
BANHO	5563AZ	060947

ÁÇO / ÁÇO INOX / ZAMAC

Orion Anatomic 55mm Roseta

ACABAMENTO	CILINDRO	MÁQUINA
BL- BRONZE LATONADO	C-700 - 56mm	55mm



EMB. INDIV.
01

EMB. COLET.
04

APLICAÇÃO	REF.	CÓDIGO
EXTERNA	55001AZ	054335
INTERNA	55002AZ	054359
BANHO	55003AZ	054366

ÁÇO / ÁÇO INOX / ZAMAC

Orion Anatomic 55mm Roseta

ACABAMENTO	CILINDRO	MÁQUINA
CR- CROMADO	C-700 - 56mm	55mm



EMB. INDIV.
01

EMB. COLET.
04

APLICAÇÃO	REF.	CÓDIGO
EXTERNA	55001AZ	054410
INTERNA	55002AZ	054434
BANHO	55003AZ	054441

ÁÇO / ÁÇO INOX / ZAMAC

Orion Anatomic Tetra 55mm Espelho

ACABAMENTO	CILINDRO	MÁQUINA
BL- BRONZE LATONADO	C-1200 - 56mm	55mm



EMB. INDIV.
01

EMB. COLET.
04

APLICAÇÃO	REF.	CÓDIGO
EXTERNA	5560AZ	056896

ÁÇO INOX / ZAMAC / LATÃO

Orion Anatomic Tetra 55mm Espelho

ACABAMENTO	CILINDRO	MÁQUINA
CR- CROMADO	C-1200 - 56mm	55mm



EMB. INDIV.
01

EMB. COLET.
04

APLICAÇÃO	REF.	CÓDIGO
EXTERNA	5560AZ	056919

ÁÇO INOX / ZAMAC / LATÃO

Orion Anatomic Kit Tetra 3X1 55mm Espelho

ACABAMENTO	CILINDRO	MÁQUINA
BL- BRONZE LATONADO	C-1200 - 56mm	55mm



EMB. INDIV.
01

EMB. COLET.
04

APLICAÇÃO	REF.	CÓDIGO
EXTERNA	5560AZ-T	058753

ÁÇO INOX
ZAMAC
LATÃO

Orion Anatomic Kit Tetra 3X1 55mm Espelho

ACABAMENTO	CILINDRO	MÁQUINA
CR- CROMADO	C-1200 - 56mm	55mm



EMB. INDIV.	01
EMB. COLET.	04

AÇO INOX
 ZAMAC
 LATÃO

APLICAÇÃO	REF.	CÓDIGO
EXTERNA	5560AZ-T	058777

Elegance 40mm Espelho

ACABAMENTO	CILINDRO	MÁQUINA
BL- BRONZE LATONADO	C-700 - 56mm	40mm



EMB. INDIV.	01
EMB. COLET.	04

APLICAÇÃO	REF.	CÓDIGO
EXTERNA	4141	064433
INTERNA	4142	064440
BANHO	4143	064457

AÇO / AÇO INOX / ZAMAC

Elegance 40mm Espelho

ACABAMENTO	CILINDRO	MÁQUINA
CR- CROMADO	C-700 - 56mm	40mm



EMB. INDIV.	01
EMB. COLET.	04

APLICAÇÃO	REF.	CÓDIGO
EXTERNA	4141	064495
INTERNA	4142	064501
BANHO	4143	064518

AÇO / AÇO INOX / ZAMAC

Elegance 40mm Roseta

ACABAMENTO	CILINDRO	MÁQUINA
BL- BRONZE LATONADO	C-700 - 56mm	40mm



EMB. INDIV.	01
EMB. COLET.	04

APLICAÇÃO	REF.	CÓDIGO
EXTERNA	4101	065362
INTERNA	4102	065379
BANHO	4103	065386

AÇO / AÇO INOX / ZAMAC

Elegance 40mm Roseta

ACABAMENTO	CILINDRO	MÁQUINA
CR- CROMADO	C-700 - 56mm	40mm



EMB. INDIV.	01
EMB. COLET.	04

APLICAÇÃO	REF.	CÓDIGO
EXTERNA	4101	065331
INTERNA	4102	065348
BANHO	4103	065355

AÇO / AÇO INOX / ZAMAC

Elegance Kit Tetra 2X1 S40mm Espelho

ACABAMENTO	CILINDRO	MÁQUINA
BL- BRONZE LATONADO	C-1200 - 56mm	S40mm



EMB. INDIV.	01
EMB. COLET.	04

AÇO INOX
 ZAMAC
 LATÃO

APLICAÇÃO	REF.	CÓDIGO
EXTERNA	4140Z-2	068851

Elegance Kit Tetra 2X1 S40mm Espelho

ACABAMENTO	CILINDRO	MÁQUINA
CR- CROMADO	C-1200 - 56mm	S40mm



EMB. INDIV.	01
EMB. COLET.	04

AÇO INOX
 ZAMAC
 LATÃO

APLICAÇÃO	REF.	CÓDIGO
EXTERNA	4140Z-2	068868

Elegance Kit Tetra 3x1 S40mm Espelho

ACABAMENTO	CILINDRO	MÁQUINA
BL- BRONZE LATONADO	C-1200 - 56mm	S40mm



EMB. INDIV.	01
EMB. COLET.	04

AÇO INOX
 ZAMAC
 LATÃO

APLICAÇÃO	REF.	CÓDIGO
EXTERNA	4140Z-T	067496

Elegance Kit Tetra 3x1 S40mm Espelho

ACABAMENTO	CILINDRO	MÁQUINA
CR- CROMADO	C-1200 - 56mm	S40mm



EMB. INDIV.	01
EMB. COLET.	04

AÇO INOX
 ZAMAC
 LATÃO

APLICAÇÃO	REF.	CÓDIGO
EXTERNA	4140Z-T	067502

Home 55mm Espelho

ACABAMENTO	CILINDRO	MÁQUINA
BL- BRONZE LATONADO	C-700 - 56mm	55mm



EMB. INDIV.
01

EMB. COLET.
04

APLICAÇÃO	REF.	CÓDIGO
EXTERNA	5581	068325

AÇO INOX / ZAMAC

Home 55mm Espelho

ACABAMENTO	CILINDRO	MÁQUINA
CR- CROMADO	C-700 - 56mm	55mm



EMB. INDIV.
01

EMB. COLET.
04

APLICAÇÃO	REF.	CÓDIGO
EXTERNA	5581	068332

AÇO INOX / ZAMAC

Home S40mm Roseta

ACABAMENTO	CILINDRO	MÁQUINA
BL- BRONZE LATONADO	C-700 - 56mm	S40mm



EMB. INDIV.
01

EMB. COLET.
04

APLICAÇÃO	REF.	CÓDIGO
EXTERNA	4151	066161
INTERNA	4152	066208
BANHO	4153	066246

AÇO / AÇO INOX / ZAMAC

Home S40mm Roseta

ACABAMENTO	CILINDRO	MÁQUINA
CR- CROMADO	C-700 - 56mm	S40mm



EMB. INDIV.
01

EMB. COLET.
04

APLICAÇÃO	REF.	CÓDIGO
EXTERNA	4151	066185
INTERNA	4152	066222
BANHO	4153	066260

AÇO / AÇO INOX / ZAMAC

Home S40mm Roseta

ACABAMENTO	CILINDRO	MÁQUINA
CRE- CROM. ESCOVADO	C-700 - 56mm	S40mm



EMB. INDIV.
01

EMB. COLET.
04

APLICAÇÃO	REF.	CÓDIGO
EXTERNA	4151	072490
INTERNA	4152	072506
BANHO	4153	072513

AÇO / AÇO INOX / ZAMAC

Home S55mm Roseta

ACABAMENTO	CILINDRO	MÁQUINA
CR- CROMADO	C-700 - 56mm	55mm



EMB. INDIV.
01

EMB. COLET.
04

APLICAÇÃO	REF.	CÓDIGO
EXTERNA	55011	066062
INTERNA	55012	066109
BANHO	55013	066147

AÇO / AÇO INOX / ZAMAC

Home S55mm Roseta

ACABAMENTO	CILINDRO	MÁQUINA
BL- BRONZE LATONADO	C-700 - 56mm	S55mm



EMB. INDIV.
01

EMB. COLET.
04

APLICAÇÃO	REF.	CÓDIGO
EXTERNA	55011	066048
INTERNA	55012	066086
BANHO	55013	066123

AÇO / AÇO INOX / ZAMAC

Home 55mm Tetra Espelho

ACABAMENTO	CILINDRO	MÁQUINA
BL- BRONZE LATONADO	C-1200 - 56mm	55mm



EMB. INDIV.
01

EMB. COLET.
04

APLICAÇÃO	REF.	CÓDIGO
EXTERNA	5585Z	072964

AÇO INOX / ZAMAC / LATÃO

Home 55mm Tetra Espelho

ACABAMENTO	CILINDRO	MÁQUINA
CR- CROMADO	C-1200 - 56mm	55mm



EMB. INDIV.
01

EMB. COLET.
04

APLICAÇÃO	REF.	CÓDIGO
EXTERNA	5585Z	072957

AÇO INOX / ZAMAC / LATÃO

Home Elegance S40mm Espelho

ACABAMENTO	CILINDRO	MÁQUINA
BL- BRONZE LATONADO	C-700 - 56mm	S40mm



EMB. INDIV.
01

EMB. COLET.
04

APLICAÇÃO	REF.	CÓDIGO
EXTERNA	4171	066284
INTERNA	4172	066321
BANHO	4173	066369

AÇO / AÇO INOX / ZAMAC

Home Elegance S40mm Espelho

ACABAMENTO	CILINDRO	MÁQUINA
CR- CROMADO	C-700 - 56mm	S40mm



EMB. INDIV.
01

EMB. COLET.
04

APLICAÇÃO	REF.	CÓDIGO
EXTERNA	4171	066307
INTERNA	4172	066345
BANHO	4173	066383

AÇO / AÇO INOX / ZAMAC

Home Elegance S40mm Tetra Espelho

ACABAMENTO	CILINDRO	MÁQUINA
BL- BRONZE LATONADO	C-1200 - 56mm	S40mm



EMB. INDIV.
01

EMB. COLET.
04

APLICAÇÃO	REF.	CÓDIGO
EXTERNA	4170 Z	067311

AÇO INOX / ZAMAC / LATÃO

Home Elegance S40mm Tetra Espelho

ACABAMENTO	CILINDRO	MÁQUINA
CR- CROMADO	C-1200 - 56mm	S40mm



EMB. INDIV.	01
EMB. COLET.	04

APLICAÇÃO	REF.	CÓDIGO
EXTERNA	4170 Z	067328

AÇO INOX / ZAMAC / LATÃO

Home Elegance Kit Tetra 2x1 S40mm Espelho

ACABAMENTO	CILINDRO	MÁQUINA
BL- BRONZE LATONADO	C-1200 - 56mm	S40mm



EMB. INDIV.	01
EMB. COLET.	04

AÇO INOX
ZAMAC
LATÃO

APLICAÇÃO	REF.	CÓDIGO
EXTERNA	4170Z-2	068837

Home Elegance Kit Tetra 2x1 S40mm Espelho

ACABAMENTO	CILINDRO	MÁQUINA
CR- CROMADO	C-1200 - 56mm	S40mm



EMB. INDIV.	01
EMB. COLET.	04

AÇO INOX
ZAMAC
LATÃO

APLICAÇÃO	REF.	CÓDIGO
EXTERNA	4170Z-2	068844

Home Elegance Kit Tetra 3x1 S40mm Espelho

ACABAMENTO	CILINDRO	MÁQUINA
BL- BRONZE LATONADO	C-1200 - 56mm	S40mm



EMB. INDIV.	01
EMB. COLET.	04

AÇO INOX
ZAMAC
LATÃO

APLICAÇÃO	REF.	CÓDIGO
EXTERNA	4170Z-T	067373

Home Elegance Kit Tetra 3x1 S40mm Espelho

ACABAMENTO	CILINDRO	MÁQUINA
CR- CROMADO	C-1200 - 56mm	S40mm



EMB. INDIV.	01
EMB. COLET.	04

AÇO INOX
ZAMAC
LATÃO

APLICAÇÃO	REF.	CÓDIGO
EXTERNA	4170Z-T	067380

Inox Classic 55mm Espelho

ACABAMENTO	CILINDRO	MÁQUINA
CR- CROMADO	C-700 - 56mm	55mm



EMB. INDIV.	01
EMB. COLET.	20

APLICAÇÃO	REF.	CÓDIGO
EXTERNA	3600/34	076542
INTERNA	3700/34	076559
BANHO	3800/34	076566

AÇO / AÇO INOX / ZAMAC

Inox Classic 55mm Espelho

ACABAMENTO	CILINDRO	MÁQUINA
CR- CROMADO	C-700 - 56mm	55mm



EMB. INDIV.	01
EMB. COLET.	20

APLICAÇÃO	REF.	CÓDIGO
EXTERNA	3600/13	016050
INTERNA	3700/13	016531
BANHO	3800/13	016913

AÇO / AÇO INOX / ZAMAC

Colonial S40mm Alavanca Espelho

ACABAMENTO	CILINDRO	MÁQUINA
ZLO - ZAMAC LAT. OXID	C-700 - 56mm	S40mm



EMB. INDIV.	01
EMB. COLET.	04

APLICAÇÃO	REF.	CÓDIGO
EXTERNA	4600/100	024581
INTERNA	4700/100	024772
BANHO	4800/100	024932

AÇO INOX / ALUMINIO / ZAMAC

Colonial S40mm Bola Espelho

ACABAMENTO	CILINDRO	MÁQUINA
ZLO - ZAMAC LAT. OXID	C-700 - 56mm	S40mm



EMB. INDIV.	01
EMB. COLET.	04

APLICAÇÃO	REF.	CÓDIGO
EXTERNA	4600/104	032494
INTERNA	4700/104	032432
BANHO	4800/104	032449

Colonial 55mm Alavanca Espelho

ACABAMENTO	CILINDRO	MÁQUINA
ZLO - ZAMAC LAT. OXID	C-700 - 56mm	55mm



EMB. INDIV.	01
EMB. COLET.	04

APLICAÇÃO	REF.	CÓDIGO
EXTERNA	3600/100	013745
INTERNA	3700/100	013998
BANHO	3800/100	014179

AÇO INOX / ALUMINIO / ZAMAC

Colonial 55mm Bola Espelho

ACABAMENTO	CILINDRO	MÁQUINA
ZLO - ZAMAC LAT. OXID	C-700 - 56mm	55mm



EMB. INDIV.	01
EMB. COLET.	04

APLICAÇÃO	REF.	CÓDIGO
EXTERNA	3600/104	013837
INTERNA	3700/104	014056
BANHO	3800/104	014230

Colonial S40mm Tetra Alavanca Espelho

ACABAMENTO	CILINDRO	MÁQUINA
ZLO - ZAMAC LAT. OXID	C-1200 - 56mm	S40mm



EMB. INDIV.	01
EMB. COLET.	04

APLICAÇÃO	REF.	CÓDIGO
EXTERNA	40100Z	054700

AÇO INOX / ALUMINIO / ZAMAC

Colonial S40mm Tetra Bola Espelho

ACABAMENTO CILINDRO MÁQUINA
ZLO - ZAMAC LAT. OXID. | C-1200 - 56mm | S40mm



EMB. INDIV.
01
EMB. COLET.
04

APLICAÇÃO	REF.	CÓDIGO
EXTERNA	40104Z	054717

AÇO INOX / ALUMÍNIO / ZAMAC

Colonial 55mm Tetra Alavanca Espelho

ACABAMENTO CILINDRO MÁQUINA
ZLO - ZAMAC LAT. OXID. | C-1200 - 56mm | 55mm



EMB. INDIV.
01
EMB. COLET.
04

APLICAÇÃO	REF.	CÓDIGO
EXTERNA	55100Z	046378

AÇO INOX / ALUMÍNIO / ZAMAC

Observação:
"/100" = maçaneta alavanca
"/104" = maçaneta bola

Colonial Kit Tetra Alavanca 2x1 S40mm Espelho

ACABAMENTO CILINDRO MÁQUINA
ZLO - ZAMAC LAT. OXID. | C-1200 - 56mm | S40mm



EMB. INDIV.
01
EMB. COLET.
04

AÇO INOX
ZAMAC
LATÃO
ALUMÍNIO

APLICAÇÃO	REF.	CÓDIGO
EXTERNA	40100Z-2	068899

Colonial Kit Tetra Alavanca 3x1 S40mm Espelho

ACABAMENTO CILINDRO MÁQUINA
ZLO - ZAMAC LAT. OXID. | C-1200 - 56mm | S40mm



EMB. INDIV.
01
EMB. COLET.
04

AÇO INOX
ZAMAC
LATÃO
ALUMÍNIO

APLICAÇÃO	REF.	CÓDIGO
EXTERNA	40100Z-T	054861

Colonial Kit Tetra Bola 3x1 S40mm Espelho

ACABAMENTO CILINDRO MÁQUINA
ZLO - ZAMAC LAT. OXID. | C-1200 - 56mm | S40mm



EMB. INDIV.
01
EMB. COLET.
04

AÇO INOX
ZAMAC
LATÃO
ALUMÍNIO

APLICAÇÃO	REF.	CÓDIGO
EXTERNA	40104Z-T	054878

Colonial Kit Tetra Alavanca 3x1 55mm Espelho

ACABAMENTO CILINDRO MÁQUINA
ZLO - ZAMAC LAT. OXID. | C-1200 - 56mm | 55mm



EMB. INDIV.
01
EMB. COLET.
04

AÇO INOX
ZAMAC
LATÃO
ALUMÍNIO

APLICAÇÃO	REF.	CÓDIGO
EXTERNA	55100Z-T	047474

Colonial Kit Tetra Bola 3x1 55mm Espelho

ACABAMENTO CILINDRO MÁQUINA
ZLO - ZAMAC LAT. | C-1200 - 56mm | 55mm



EMB. INDIV.
01
EMB. COLET.
04

AÇO INOX
ZAMAC
LATÃO
ALUMÍNIO

APLICAÇÃO	REF.	CÓDIGO
EXTERNA	55104Z-T	044428

Fechaduras

Onda S40mm Espelho

ACABAMENTO	CILINDRO	MÁQUINA
BL- BRONZE LATONADO	C-700 - 56mm	S40mm



EMB. INDIV.	01
EMB. COLET.	04

APLICAÇÃO	REF.	CÓDIGO
EXTERNA	4121	078515
INTERNA	4122	078522
BANHO	4123	078539

AÇO / AÇO INOX / ZAMAC

Onda S40mm Espelho

ACABAMENTO	CILINDRO	MÁQUINA
CR- CROMADO	C-700 - 56mm	S40mm



EMB. INDIV.	01
EMB. COLET.	04

APLICAÇÃO	REF.	CÓDIGO
EXTERNA	4121	078454
INTERNA	4122	078461
BANHO	4123	078478

AÇO / AÇO INOX / ZAMAC

Onda S40mm Roseta

ACABAMENTO	CILINDRO	MÁQUINA
BL- BRONZE LATONADO	C-700 - 56mm	S40mm



EMB. INDIV.	01
EMB. COLET.	04

APLICAÇÃO	REF.	CÓDIGO
EXTERNA	4131	078423
INTERNA	4132	078430
BANHO	4133	078447

AÇO / AÇO INOX / ZAMAC

Onda S40mm Roseta

ACABAMENTO	CILINDRO	MÁQUINA
CR- CROMADO	C-700 - 56mm	S40mm



EMB. INDIV.	01
EMB. COLET.	04

APLICAÇÃO	REF.	CÓDIGO
EXTERNA	4131	078362
INTERNA	4132	078379
BANHO	4133	078386

AÇO / AÇO INOX / ZAMAC

Maxx S40mm Espelho

ACABAMENTO	CILINDRO	MÁQUINA
BL- BRONZE LATONADO	C-700 - 56mm	S40mm



EMB. INDIV.	01
EMB. COLET.	04

APLICAÇÃO	REF.	CÓDIGO
EXTERNA	4511	083946
INTERNA	4512	083977
BANHO	4513	084004

AÇO / AÇO INOX / ZAMAC

Maxx S40mm Espelho

ACABAMENTO	CILINDRO	MÁQUINA
CR- CROMADO	C-700 - 56mm	S40mm



EMB. INDIV.	01
EMB. COLET.	04

APLICAÇÃO	REF.	CÓDIGO
EXTERNA	4511	083922
INTERNA	4512	083953
BANHO	4513	083984

AÇO / AÇO INOX / ZAMAC

Maxx S40mm Espelho

ACABAMENTO	CILINDRO	MÁQUINA
PF- PRETO FOSCO	C-700 - 56mm	S40mm



EMB. INDIV.	01
EMB. COLET.	04

APLICAÇÃO	REF.	CÓDIGO
EXTERNA	4511	083939
INTERNA	4512	083960
BANHO	4513	083991

AÇO / AÇO INOX / ZAMAC

Maxx S40mm Roseta

ACABAMENTO	CILINDRO	MÁQUINA
BL- BRONZE LATONADO	C-700 - 56mm	S40mm



EMB. INDIV.	01
EMB. COLET.	04

APLICAÇÃO	REF.	CÓDIGO
EXTERNA	4641	083854
INTERNA	4642	083885
BANHO	4643	083915

AÇO / AÇO INOX / ZAMAC

Maxx S40mm Roseta

ACABAMENTO	CILINDRO	MÁQUINA
CR- CROMADO	C-700 - 56mm	S40mm



EMB. INDIV.	01
EMB. COLET.	04

APLICAÇÃO	REF.	CÓDIGO
EXTERNA	4641	083830
INTERNA	4642	083861
BANHO	4643	083892

AÇO / AÇO INOX / ZAMAC

Maxx S40mm Roseta

ACABAMENTO	CILINDRO	MÁQUINA
PF- PRETO FOSCO	C-700 - 56mm	S40mm



EMB. INDIV.	01
EMB. COLET.	04

APLICAÇÃO	REF.	CÓDIGO
EXTERNA	4641	083847
INTERNA	4642	083878
BANHO	4643	083908

AÇO / AÇO INOX / ZAMAC

Galaxy 40mm Espelho

ACABAMENTO	CILINDRO	MÁQUINA
BL- BRONZE LATONADO	C-700 - 56mm	40mm



EMB. INDIV.	01
EMB. COLET.	20

APLICAÇÃO	REF.	CÓDIGO
EXTERNA	4191	069858
INTERNA	4192	069865
BANHO	4193	069872

AÇO / AÇO INOX / ZAMAC

Galaxy 40mm Espelho

ACABAMENTO	CILINDRO	MÁQUINA
CR- CROMADO	C-700 - 56mm	40mm



EMB. INDIV.	01
EMB. COLET.	20

APLICAÇÃO	REF.	CÓDIGO
EXTERNA	4191	069827
INTERNA	4192	069834
BANHO	4193	069841

AÇO / AÇO INOX / ZAMAC

Galaxy 40mm Espelho

ACABAMENTO	CILINDRO	MÁQUINA
PF- PRETO FOSCO	C-700 - 56mm	40mm



EMB. INDIV.	01
EMB. COLET.	20

APLICAÇÃO	REF.	CÓDIGO
EXTERNA	4191	082536
INTERNA	4192	082543
BANHO	4193	082550

AÇO / AÇO INOX / ZAMAC

Galaxy 40mm Roseta

ACABAMENTO	CILINDRO	MÁQUINA
BL- BRONZE LATONADO	C-700 - 56mm	40mm



EMB. INDIV.	01
EMB. COLET.	20

APLICAÇÃO	REF.	CÓDIGO
EXTERNA	4181	069766
INTERNA	4182	069773
BANHO	4183	069780

AÇO / AÇO INOX / ZAMAC

Galaxy 40mm Roseta

ACABAMENTO	CILINDRO	MÁQUINA
CR- CROMADO	C-700 - 56mm	40mm



EMB. INDIV.	01
EMB. COLET.	20

APLICAÇÃO	REF.	CÓDIGO
EXTERNA	4181	069735
INTERNA	4182	069742
BANHO	4183	069759

AÇO / AÇO INOX / ZAMAC

Galaxy 40mm Roseta

ACABAMENTO	CILINDRO	MÁQUINA
CRE- CROM. ESCOVADO	C-700 - 56mm	40mm



EMB. INDIV.	01
EMB. COLET.	20

APLICAÇÃO	REF.	CÓDIGO
EXTERNA	4181	072551
INTERNA	4182	072568
BANHO	4183	072575

AÇO / AÇO INOX / ZAMAC

Galaxy 40mm Roseta

ACABAMENTO	CILINDRO	MÁQUINA
PF- PRETO FOSCO	C-700 - 56mm	40mm



EMB. INDIV.	01
EMB. COLET.	20

APLICAÇÃO	REF.	CÓDIGO
EXTERNA	4181	082505
INTERNA	4182	082512
BANHO	4183	082529

AÇO / AÇO INOX / ZAMAC

Galaxy 40mm Roseta

ACABAMENTO	CILINDRO	MÁQUINA
FU- FUME	C-400 - 48mm	40mm



EMB. INDIV.	01
EMB. COLET.	20

APLICAÇÃO	REF.	CÓDIGO
EXTERNA	4281	081386
INTERNA	4282	081393
BANHO	4283	081409

AÇO / AÇO INOX / ZAMAC

Galaxy S40mm Tetra Espelho

ACABAMENTO	CILINDRO	MÁQUINA
BL- BRONZE LATONADO	C-1200 - 56mm	S40mm



EMB. INDIV.	01
EMB. COLET.	04

APLICAÇÃO	REF.	CÓDIGO
EXTERNA	4180 Z	072988

AÇO INOX / ZAMAC / LATÃO

Galaxy S40mm Tetra Espelho

ACABAMENTO	CILINDRO	MÁQUINA
CR- CROMADO	C-1200 - 56mm	S40mm



EMB. INDIV.	01
EMB. COLET.	04

APLICAÇÃO	REF.	CÓDIGO
EXTERNA	4180 Z	072971

AÇO INOX / ZAMAC / LATÃO

Galaxy Kit Tetra 2x1 S40mm Espelho

ACABAMENTO	CILINDRO	MÁQUINA
BL- BRONZE LATONADO	C-1200 - 56mm	S40mm



EMB. INDIV.	01
EMB. COLET.	04

AÇO INOX
ZAMAC
LATÃO

APLICAÇÃO	REF.	CÓDIGO
EXTERNA	4180 Z-2	072834

Fechaduras

Galaxy Kit Tetra 2x1 S40mm Espelho

ACABAMENTO	CILINDRO	MÁQUINA
CR- CROMADO	C-1200 - 56mm	S40mm



EMB. INDIV.	01
EMB. COLET.	04

AÇO INOX
 ZAMAC
 LATÃO

APLICAÇÃO	REF.	CÓDIGO
EXTERNA	4180 Z-2	072841

Galaxy Kit Tetra 3x1 S40mm Espelho

ACABAMENTO	CILINDRO	MÁQUINA
BL- BRONZE LATONADO	C-1200 - 56mm	S40mm



EMB. INDIV.	01
EMB. COLET.	04

AÇO INOX
 ZAMAC
 LATÃO

APLICAÇÃO	REF.	CÓDIGO
EXTERNA	4180 Z-T	072902

Galaxy Kit Tetra 3x1 S40mm Espelho

ACABAMENTO	CILINDRO	MÁQUINA
CR- CROMADO	C-1200 - 56mm	S40mm



EMB. INDIV.	01
EMB. COLET.	04

AÇO INOX
 ZAMAC
 LATÃO

APLICAÇÃO	REF.	CÓDIGO
EXTERNA	4180 Z-2	072919

Vega S40mm Espelho

ACABAMENTO	CILINDRO	MÁQUINA
BL- BRONZE LATONADO	C-700 - 56mm	S40mm



EMB. INDIV.	01
EMB. COLET.	20

APLICAÇÃO	REF.	CÓDIGO
EXTERNA	4811	083762
INTERNA	4812	083793
BANHO	4813	083823

AÇO / AÇO INOX / ZAMAC

Vega S40mm Espelho

ACABAMENTO	CILINDRO	MÁQUINA
CR- CROMADO	C-700 - 56mm	S40mm



EMB. INDIV.	01
EMB. COLET.	20

APLICAÇÃO	REF.	CÓDIGO
EXTERNA	4811	083748
INTERNA	4812	083779
BANHO	4813	083809

AÇO / AÇO INOX / ZAMAC

Vega S40mm Espelho

ACABAMENTO	CILINDRO	MÁQUINA
PF- PRETO FOSCO	C-700 - 56mm	S40mm



EMB. INDIV.	01
EMB. COLET.	20

APLICAÇÃO	REF.	CÓDIGO
EXTERNA	4811	083755
INTERNA	4812	083786
BANHO	4813	083816

AÇO / AÇO INOX / ZAMAC

Vega S40mm Roseta

ACABAMENTO	CILINDRO	MÁQUINA
BL- BRONZE LATONADO	C-700 - 56mm	S40mm



EMB. INDIV.	01
EMB. COLET.	20

APLICAÇÃO	REF.	CÓDIGO
EXTERNA	4741	083670
INTERNA	4742	083700
BANHO	4743	083731

AÇO INOX / ALUMINIO / ZAMAC

Vega S40mm Roseta

ACABAMENTO	CILINDRO	MÁQUINA
CR- CROMADO	C-700 - 56mm	S40mm



EMB. INDIV.	01
EMB. COLET.	20

APLICAÇÃO	REF.	CÓDIGO
EXTERNA	4741	083656
INTERNA	4742	083687
BANHO	4743	083717

AÇO INOX / ALUMINIO / ZAMAC

Vega S40mm Roseta

ACABAMENTO	CILINDRO	MÁQUINA
PF- PRETO FOSCO	C-700 - 56mm	S40mm



EMB. INDIV.	01
EMB. COLET.	20

APLICAÇÃO	REF.	CÓDIGO
EXTERNA	4741	083663
INTERNA	4742	083694
BANHO	4743	083724

AÇO / AÇO INOX / ZAMAC

Taco de Golf 40mm Espelho

ACABAMENTO	CILINDRO	MÁQUINA
IP- INOX POLIDO	C-400 - 48mm	40mm



EMB. INDIV.	01
EMB. COLET.	20

APLICAÇÃO	REF.	CÓDIGO
EXTERNA	2600/80	064075
INTERNA	2700/80	064082
BANHO	2800/80	064099

AÇO INOX / ALUMINIO / ZAMAC

Taco de Golf 40mm Espelho

ACABAMENTO	CILINDRO	MÁQUINA
BLF- BRO.LAT. FOSCO	C-400 - 48mm	40mm



EMB. INDIV.	01
EMB. COLET.	20

APLICAÇÃO	REF.	CÓDIGO
EXTERNA	2600/80	062590
INTERNA	2700/80	062606
BANHO	2800/80	062613

AÇO INOX / ALUMINIO / ZAMAC

Pop 40mm Espelho

ACABAMENTO	CILINDRO	MÁQUINA
BL- BRONZE LATONADO	C-400 - 48mm	40mm



EMB. INDIV.	01
EMB. COLET.	20

APLICAÇÃO	REF.	CÓDIGO
EXTERNA	2600/90	069582
INTERNA	2700/90	069599
BANHO	2800/90	069605

AÇO INOX / ALUMINIO / ZAMAC

Pop 40mm Espelho

ACABAMENTO	CILINDRO	MÁQUINA
IP- INOX POLIDO	C-400 - 48mm	40mm



EMB. INDIV.	01
EMB. COLET.	20

APLICAÇÃO	REF.	CÓDIGO
EXTERNA	2600/90	069551
INTERNA	2700/90	069568
BANHO	2800/90	069575

AÇO INOX / ALUMINIO / ZAMAC

Pop 40mm Espelho

ACABAMENTO	CILINDRO	MÁQUINA
BLF- BRO.LAT. FOSCO	C-400 - 48mm	40mm



EMB. INDIV.	01
EMB. COLET.	20

APLICAÇÃO	REF.	CÓDIGO
EXTERNA	2600/90	071875
INTERNA	2700/90	071882
BANHO	2800/90	071899

AÇO INOX / ALUMINIO / ZAMAC

Pop Premium 40mm Espelho

ACABAMENTO	CILINDRO	MÁQUINA
BL- BRONZE LATONADO	C-400 - 48mm	40mm



EMB. INDIV.	01
EMB. COLET.	40

APLICAÇÃO	REF.	CÓDIGO
EXTERNA	2600/70	061227
INTERNA	2700/70	061234
BANHO	2800/70	061241

AÇO INOX / ALUMINIO / ZAMAC

Joy 40mm Espelho

ACABAMENTO	CILINDRO	MÁQUINA
BL- BRONZE LATONADO	C-400 - 48mm	40mm



EMB. INDIV.	01
EMB. COLET.	40

APLICAÇÃO	REF.	CÓDIGO
EXTERNA	2600/46	083359
INTERNA	2700/46	083397
BANHO	2800/46	083434

AÇO INOX / ALUMINIO / ZAMAC

Joy 40mm Espelho

ACABAMENTO	CILINDRO	MÁQUINA
IP- INOX POLIDO	C-400 - 48mm	40mm



EMB. INDIV.	01
EMB. COLET.	40

APLICAÇÃO	REF.	CÓDIGO
EXTERNA	2600/46	083328
INTERNA	2700/46	083366
BANHO	2800/46	083403

AÇO INOX / ALUMINIO / ZAMAC

Joy 40mm Espelho

ACABAMENTO	CILINDRO	MÁQUINA
PF- PRETO FOSCO	C-400 - 48mm	40mm



EMB. INDIV.	01
EMB. COLET.	40

APLICAÇÃO	REF.	CÓDIGO
EXTERNA	2600/46	083342
INTERNA	2700/46	083380
BANHO	2800/46	083427

AÇO INOX / ALUMINIO / ZAMAC

Joy 40mm Espelho

ACABAMENTO	CILINDRO	MÁQUINA
BC- BRANCO	C-400 - 48mm	40mm



EMB. INDIV.	01
EMB. COLET.	40

APLICAÇÃO	REF.	CÓDIGO
EXTERNA	2600/46	083335
INTERNA	2700/46	083373
BANHO	2800/46	083410

AÇO INOX / ALUMINIO / ZAMAC

Joy 40mm Espelho

ACABAMENTO	CILINDRO	MÁQUINA
BL- BRONZE LATONADO	C-400 - 48mm	40mm



EMB. INDIV.	01
EMB. COLET.	40

APLICAÇÃO	REF.	CÓDIGO
EXTERNA	2600/241	083472
INTERNA	2700/241	083519
BANHO	2800/241	083557

AÇO INOX / ALUMINIO / ZAMAC

Joy 40mm Espelho

ACABAMENTO	CILINDRO	MÁQUINA
IP- INOX POLIDO	C-400 - 48mm	40mm



EMB. INDIV.	01
EMB. COLET.	40

APLICAÇÃO	REF.	CÓDIGO
EXTERNA	2600/241	083441
INTERNA	2700/241	083489
BANHO	2800/241	083526

AÇO INOX / ALUMINIO / ZAMAC

Joy 40mm Espelho

ACABAMENTO	CILINDRO	MÁQUINA
PF- PRETO FOSCO	C-400 - 48mm	40mm



EMB. INDIV.	01
EMB. COLET.	40

APLICAÇÃO	REF.	CÓDIGO
EXTERNA	2600/241	083465
INTERNA	2700/241	083502
BANHO	2800/241	083540

AÇO INOX / ALUMINIO / ZAMAC

Joy 40mm Espelho

ACABAMENTO	CILINDRO	MÁQUINA
BC- BRANCO	C-400 - 48mm	40mm



EMB. INDIV.	01
EMB. COLET.	40

APLICAÇÃO	REF.	CÓDIGO
EXTERNA	2600/241	083458
INTERNA	2700/241	083496
BANHO	2800/241	083533

AÇO INOX / ALUMINIO / ZAMAC

Joy 40mm Roseta

ACABAMENTO	CILINDRO	MÁQUINA
BL- BRONZE LATONADO	C-700 - 56mm	40mm



EMB. INDIV.	01
EMB. COLET.	40

APLICAÇÃO	REF.	CÓDIGO
EXTERNA	2600/63	083588
INTERNA	2700/63	083618
BANHO	2800/63	083649

AÇO INOX / ALUMINIO / ZAMAC

Fechaduras

Joy 40mm Espelho

ACABAMENTO	CILINDRO	MÁQUINA
IP- INOX POLIDO	C-700 - 56mm	40mm



EMB. INDIV.
01
EMB. COLET.
40

APLICAÇÃO	REF.	CÓDIGO
EXTERNA	2600/63	083564
INTERNA	2700/63	083595
BANHO	2800/63	083625

AÇO INOX / ALUMINIO / ZAMAC

Joy 40mm Roseta

ACABAMENTO	CILINDRO	MÁQUINA
PF- PRETO FOSCO	C-700 - 56mm	40mm



EMB. INDIV.
01
EMB. COLET.
40

APLICAÇÃO	REF.	CÓDIGO
EXTERNA	2600/63	083571
INTERNA	2700/63	083601
BANHO	2800/63	083632

AÇO INOX / ALUMINIO / ZAMAC

Quadratta Premium 40mm Roseta

ACABAMENTO	CILINDRO	MÁQUINA
IP- INOX POLIDO	C-400 - 48mm	40mm



EMB. INDIV.
01
EMB. COLET.
40

APLICAÇÃO	REF.	CÓDIGO
EXTERNA	2600/81	080075
INTERNA	2700/81	080082
BANHO	2800/81	080099

AÇO INOX / ALUMINIO / ZAMAC

Quadratta Premium 40mm Roseta

ACABAMENTO	CILINDRO	MÁQUINA
FU- FUME	C-400 - 48mm	40mm



EMB. INDIV.
01
EMB. COLET.
40

APLICAÇÃO	REF.	CÓDIGO
EXTERNA	2600/81	081263
INTERNA	2700/81	081270
BANHO	2800/81	081287

AÇO INOX / ALUMINIO / ZAMAC

Inox Premium 40mm Espelho

ACABAMENTO	CILINDRO	MÁQUINA
IP- INOX POLIDO	C-400 - 48mm	40mm



EMB. INDIV.
01
EMB. COLET.
40

APLICAÇÃO	REF.	CÓDIGO
EXTERNA	2600/31	071998
INTERNA	2700/31	072001
BANHO	2800/31	072018

AÇO INOX / ALUMINIO / ZAMAC

Inox Premium 40mm Espelho

ACABAMENTO	CILINDRO	MÁQUINA
IP- INOX POLIDO	C-400 - 48mm	40mm



EMB. INDIV.
01
EMB. COLET.
40

APLICAÇÃO	REF.	CÓDIGO
EXTERNA	2600/41	071936
INTERNA	2700/41	071943
BANHO	2800/41	071950

AÇO INOX / ALUMINIO / ZAMAC

Inox Premium 40mm Espelho

ACABAMENTO	CILINDRO	MÁQUINA
IP- INOX POLIDO	C-400 - 48mm	40mm



EMB. INDIV.
01
EMB. COLET.
40

APLICAÇÃO	REF.	CÓDIGO
EXTERNA	2600/71	071967
INTERNA	2700/71	071974
BANHO	2800/71	071981

AÇO INOX / ALUMINIO / ZAMAC

Inox Premium 40mm Espelho

ACABAMENTO	CILINDRO	MÁQUINA
IP- INOX POLIDO	C-400 - 48mm	40mm



EMB. INDIV.
01
EMB. COLET.
40

APLICAÇÃO	REF.	CÓDIGO
EXTERNA	2600/60	073343
INTERNA	2700/60	073350
BANHO	2800/60	073367

AÇO INOX / ALUMINIO / ZAMAC

Inox Premium 40mm Roseta

ACABAMENTO	CILINDRO	MÁQUINA
IP- INOX POLIDO	C-400 - 48mm	40mm



EMB. INDIV.
01
EMB. COLET.
40

APLICAÇÃO	REF.	CÓDIGO
EXTERNA	2600/11	024529
INTERNA	2700/11	025014
BANHO	2800/11	024871

AÇO INOX / ALUMINIO / ZAMAC

Fechadura Rolete 55mm Roseta quadrada

ACABAMENTO	CILINDRO	MÁQUINA
BL- BRONZE LATONADO	C-700 - 56mm	55mm



EMB. INDIV.
01
EMB. COLET.
06

APLICAÇÃO	REF.	CÓDIGO
EXTERNA	5600/10	073022

AÇO INOX / ZAMAC

Fechadura Rolete 55mm Roseta quadrada

ACABAMENTO	CILINDRO	MÁQUINA
CR- CROMADO	C-700 - 56mm	55mm



EMB. INDIV.
01
EMB. COLET.
06

APLICAÇÃO	REF.	CÓDIGO
EXTERNA	5600/10	071103

AÇO INOX / ZAMAC

Fechadura Rolete 55mm Roseta quadrada

ACABAMENTO	CILINDRO	MÁQUINA
CRE- CROM. ESCOVADO	C-700 - 56mm	55mm



EMB. INDIV.
01
EMB. COLET.
06

APLICAÇÃO	REF.	CÓDIGO
EXTERNA	5600/10	071530

AÇO INOX / ZAMAC

Observação: As fechaduras 2600/11 atendem apenas portas com espessura até 35mm

Fechadura Rolete 55mm Roseta redonda

ACABAMENTO	CILINDRO	MÁQUINA
BL- BRONZE LATONADO	C-700 - 56mm	55mm



EMB. INDIV.	01
EMB. COLET.	06

APLICAÇÃO	REF.	CÓDIGO
EXTERNA	5600/20	073046

ÁÇO INOX / ZAMAC

Fechadura Rolete 55mm Roseta redonda

ACABAMENTO	CILINDRO	MÁQUINA
CR- CROMADO	C-700 - 56mm	55mm



EMB. INDIV.	01
EMB. COLET.	06

APLICAÇÃO	REF.	CÓDIGO
EXTERNA	5600/20	071110

ÁÇO INOX / ZAMAC

Fechadura Rolete 55mm Roseta redonda

ACABAMENTO	CILINDRO	MÁQUINA
CRE- CROM. ESCOVADO	C-700 - 56mm	55mm



EMB. INDIV.	01
EMB. COLET.	06

APLICAÇÃO	REF.	CÓDIGO
EXTERNA	5600/20	071547

ÁÇO INOX / ZAMAC

Rolete 55mm Roseta Tetra quadrada

ACABAMENTO	CILINDRO	MÁQUINA
CR- CROMADO	C-1200 - 56mm	55mm



EMB. INDIV.	01
EMB. COLET.	06

APLICAÇÃO	REF.	CÓDIGO
EXTERNA	5600/30	076801

ÁÇO INOX / ZAMAC

Rolete 55mm Roseta Tetra quadrada

ACABAMENTO	CILINDRO	MÁQUINA
CRE- CROM. ESCOVADO	C-1200 - 56mm	55mm



EMB. INDIV.	01
EMB. COLET.	06

APLICAÇÃO	REF.	CÓDIGO
EXTERNA	5600/30	076825

ÁÇO INOX / ZAMAC

Rolete 55mm Roseta Tetra quadrada + F2000

ACABAMENTO	CILINDRO	MÁQUINA
CR- CROMADO	C-1200 - 56mm	55mm



EMB. INDIV.	01
EMB. COLET.	06

APLICAÇÃO	REF.	CÓDIGO
EXTERNA	5600/40	076818

ÁÇO INOX / ZAMAC

Rolete 55mm Roseta Tetra quadrada + F2000

ACABAMENTO	CILINDRO	MÁQUINA
CRE- CROM. ESCOVADO	C-1200 - 56mm	55mm



EMB. INDIV.	01
EMB. COLET.	06

APLICAÇÃO	REF.	CÓDIGO
EXTERNA	5600/40	076832

ÁÇO INOX / ZAMAC

Rolete 55mm Roseta quadrada Blister

ACABAMENTO	CILINDRO	MÁQUINA
BL- BRONZE LATONADO	C-700 - 56mm	55mm



EMB. INDIV.	05
EMB. COLET.	05

ÁÇO INOX
ZAMAC

APLICAÇÃO	REF.	CÓDIGO
EXTERNA	5600/10	073060

Rolete 55mm Roseta quadrada Blister

ACABAMENTO	CILINDRO	MÁQUINA
CR- CROMADO	C-700 - 56mm	55mm



EMB. INDIV.	05
EMB. COLET.	05

ÁÇO INOX
ZAMAC

APLICAÇÃO	REF.	CÓDIGO
EXTERNA	5600/10	070908

Rolete 55mm Roseta quadrada Blister

ACABAMENTO	CILINDRO	MÁQUINA
CRE- CROM. ESCOVADO	C-700 - 56mm	55mm



EMB. INDIV.	05
EMB. COLET.	05

ÁÇO INOX
ZAMAC

APLICAÇÃO	REF.	CÓDIGO
EXTERNA	5600/10	071554

Rolete 55mm Roseta redonda Blister

ACABAMENTO	CILINDRO	MÁQUINA
BL- BRONZE LATONADO	C-700 - 56mm	55mm



EMB. INDIV.	05
EMB. COLET.	05

ÁÇO INOX
ZAMAC

APLICAÇÃO	REF.	CÓDIGO
EXTERNA	5600/20	073084

Rolete 55mm Roseta redonda Blister

ACABAMENTO	CILINDRO	MÁQUINA
CR- CROMADO	C-700 - 56mm	55mm



EMB. INDIV.	05
EMB. COLET.	05

ÁÇO INOX
ZAMAC

APLICAÇÃO	REF.	CÓDIGO
EXTERNA	5600/20	070915

Rolete 55mm Roseta redonda Blister

ACABAMENTO CILINDRO MÁQUINA
CRE- CROM. ESCOVADO | C-700 - 56mm | 55mm



EMB. INDIV.
05
EMB. COLET.
05
AÇO INOX ZAMAC

APLICAÇÃO	REF.	CÓDIGO
EXTERNA	5600/20	071561

Fechadura de Portão F-1500 100mm

ACABAMENTO DISTÂNCIA DA CAIXA
PF- PRETO FOSCO | 100mm



EMB. INDIV.
01
EMB. COLET.
25
AÇO

APLICAÇÃO	REF.	CÓDIGO
EXTERNA	F-1500	012687

Fechadura de Portão F-1500 100mm

ACABAMENTO DISTÂNCIA DA CAIXA
PR- PRATA | 100mm



EMB. INDIV.
01
EMB. COLET.
25
AÇO

APLICAÇÃO	REF.	CÓDIGO
EXTERNA	F-1500	069537

Fechadura de Portão F-1500 100mm

ACABAMENTO DISTÂNCIA DA CAIXA
BC- BRANCO | 100mm



EMB. INDIV.
01
EMB. COLET.
25
AÇO

APLICAÇÃO	REF.	CÓDIGO
EXTERNA	F-1500	084196

Fechadura de Portão Tetra F-1510 100mm

ACABAMENTO DISTÂNCIA DA CAIXA
PF- PRETO FOSCO | 100mm



EMB. INDIV.
01
EMB. COLET.
25
AÇO

APLICAÇÃO	REF.	CÓDIGO
EXTERNA	F-1510	068554

Fechadura de Portão Tetra F-1510 100mm

ACABAMENTO DISTÂNCIA DA CAIXA
PR- PRATA | 100mm



EMB. INDIV.
01
EMB. COLET.
25
AÇO

APLICAÇÃO	REF.	CÓDIGO
EXTERNA	F-1510	069544

Fechadura de Portão Tetra F-1510 100mm

ACABAMENTO DISTÂNCIA DA CAIXA
BC- BRANCO | 100mm



EMB. INDIV.
01
EMB. COLET.
25
AÇO

APLICAÇÃO	REF.	CÓDIGO
EXTERNA	F-1510	084202

Fechadura Tipo Caixa Sobrepor F-1072

ACABAMENTO DISTÂNCIA DA CAIXA
CZ- CINZA | 80mm



EMB. INDIV.
01
EMB. COLET.
100
AÇO

APLICAÇÃO	REF.	CÓDIGO
EXTERNA	F-1072	012595

Fechadura Tipo Caixa Sobrepor F-1072

ACABAMENTO DISTÂNCIA DA CAIXA
CZ- CINZA | 80mm



EMB. INDIV.
10
EMB. COLET.
100
AÇO

APLICAÇÃO	REF.	CÓDIGO
EXTERNA	F-1072	057794

Fechadura Porta de correr F-1300

ACABAMENTO CILINDRO MÁQUINA
IP- INOX POLIDO | C-400 - 48mm | 24mm



EMB. INDIV.
01
EMB. COLET.
50
AÇO ZAMAC

APLICAÇÃO	REF.	CÓDIGO
EXTERNA	F-1300	012618

Fechadura Porta de correr F-1300

ACABAMENTO CILINDRO MÁQUINA
BC- BRANCO | C-400 - 48mm | 24mm



EMB. INDIV.
01
EMB. COLET.
50
AÇO ZAMAC

APLICAÇÃO	REF.	CÓDIGO
EXTERNA	F-1300	070588

Fechadura Porta de correr F-1300

ACABAMENTO CILINDRO MÁQUINA
PF- PRETO FOSCO | C-400 - 48mm | 24mm



EMB. INDIV.
01
EMB. COLET.
50
AÇO ZAMAC

APLICAÇÃO	REF.	CÓDIGO
EXTERNA	F-1300	012625

Fechadura Porta de correr F-1320

ACABAMENTO	CILINDRO	MÁQUINA
IP- INOX POLIDO	C-400 - 48mm	19mm



EMB. INDIV.	01
EMB. COLET.	50

AÇO
ZAMAC

APLICAÇÃO	REF.	CÓDIGO
EXTERNA	F-1320	078546

Fechadura Porta de correr F-1320

ACABAMENTO	CILINDRO	MÁQUINA
PF- PRETO FOSCO	C-400 - 48mm	19mm



EMB. INDIV.	01
EMB. COLET.	50

AÇO
ZAMAC

APLICAÇÃO	REF.	CÓDIGO
EXTERNA	F-1320	078553

Fechadura Porta de correr F-1340

ACABAMENTO	CILINDRO	MÁQUINA
IP- INOX POLIDO	1/2	24mm



EMB. INDIV.	01
EMB. COLET.	50

AÇO
ZAMAC

APLICAÇÃO	REF.	CÓDIGO
EXTERNA	F-1340	028220

Fechadura Porta de correr F-1340

ACABAMENTO	CILINDRO	MÁQUINA
PF- PRETO FOSCO	1/2	24mm



EMB. INDIV.	01
EMB. COLET.	50

AÇO
ZAMAC

APLICAÇÃO	REF.	CÓDIGO
EXTERNA	F-1340	028237

Fechadura Perfil estreito F-1400

ACABAMENTO	CILINDRO	MÁQUINA
IP- INOX POLIDO	C-400 - 48mm	14,4mm



EMB. INDIV.	01
EMB. COLET.	40

AÇO INOX
ZAMAC

APLICAÇÃO	REF.	CÓDIGO
EXTERNA	F-1400	012649

Fechadura Perfil estreito F-1400

ACABAMENTO	CILINDRO	MÁQUINA
PF- PRETO FOSCO	C-400 - 48mm	14,4mm



EMB. INDIV.	01
EMB. COLET.	40

AÇO INOX
ZAMAC

APLICAÇÃO	REF.	CÓDIGO
EXTERNA	F-1400	012632

Fechadura Perfil estreito F-1400

ACABAMENTO	CILINDRO	MÁQUINA
BC- BRANCO	C-400 - 48mm	14,4mm



EMB. INDIV.	01
EMB. COLET.	40

AÇO INOX
ZAMAC

APLICAÇÃO	REF.	CÓDIGO
EXTERNA	F-1400	070595

Fechadura Perfil estreito F-1440

ACABAMENTO	CILINDRO	MÁQUINA
IP- INOX POLIDO	1/2	14,4mm



EMB. INDIV.	01
EMB. COLET.	40

AÇO INOX
ZAMAC

APLICAÇÃO	REF.	CÓDIGO
EXTERNA	F-1440	012663

Joy Perfil estreito F-2400

ACABAMENTO	CILINDRO	MÁQUINA
IP- INOX POLIDO	C-400 - 48mm	22mm



EMB. INDIV.	01
EMB. COLET.	40

AÇO INOX
ZAMAC

APLICAÇÃO	REF.	CÓDIGO
EXTERNA	F-2400	083267

Joy Perfil estreito F-2400

ACABAMENTO	CILINDRO	MÁQUINA
PF- PRETO FOSCO	C-400 - 48mm	22mm



EMB. INDIV.	01
EMB. COLET.	40

AÇO INOX
ZAMAC

APLICAÇÃO	REF.	CÓDIGO
EXTERNA	F-2400	083281

Joy Perfil estreito F-2400

ACABAMENTO	CILINDRO	MÁQUINA
BC- BRANCO	C-400 - 48mm	22mm



EMB. INDIV.	01
EMB. COLET.	40

AÇO INOX
 ZAMAC

APLICAÇÃO	REF.	CÓDIGO
EXTERNA	F-2400	083274

Fechadura Perfil estreito F-2400

ACABAMENTO	CILINDRO	MÁQUINA
IP- INOX POLIDO	C-400 - 48mm	22mm



EMB. INDIV.	01
EMB. COLET.	40

AÇO INOX
 ZAMAC

APLICAÇÃO	REF.	CÓDIGO
EXTERNA	F-2400	029357

Fechadura Perfil estreito F-2400

ACABAMENTO	CILINDRO	MÁQUINA
PF- PRETO FOSCO	C-400 - 48mm	22mm



EMB. INDIV.	01
EMB. COLET.	40

AÇO INOX
 ZAMAC

APLICAÇÃO	REF.	CÓDIGO
EXTERNA	F-2400	029807

Perfil estreito F-2400 C/ Acionamento

ACABAMENTO	CILINDRO	MÁQUINA
IP- INOX POLIDO	C-400 - 48mm	22mm



EMB. INDIV.	01
EMB. COLET.	40

AÇO INOX
 ZAMAC

APLICAÇÃO	REF.	CÓDIGO
EXTERNA	F-2400A	029371

Perfil estreito F-2400 C/ Acionamento

ACABAMENTO	CILINDRO	MÁQUINA
PF- PRETO FOSCO	C-400 - 48mm	22mm



EMB. INDIV.	01
EMB. COLET.	40

AÇO INOX
 ZAMAC

APLICAÇÃO	REF.	CÓDIGO
EXTERNA	F-2400A	029821

Perfil estreito F-2400 C/ Acionamento

ACABAMENTO	CILINDRO	MÁQUINA
BC- BRANCO	C-400 - 48mm	22mm



EMB. INDIV.	01
EMB. COLET.	40

AÇO INOX
 ZAMAC

APLICAÇÃO	REF.	CÓDIGO
EXTERNA	F-2400A	070601

Joy Perfil estreito F-2500

ACABAMENTO	CILINDRO	MÁQUINA
IP- INOX POLIDO	C-400 - 48mm	28mm



EMB. INDIV.	01
EMB. COLET.	04

AÇO INOX
 ZAMAC

APLICAÇÃO	REF.	CÓDIGO
EXTERNA	F-2500	083298

Joy Perfil estreito F-2500

ACABAMENTO	CILINDRO	MÁQUINA
PF- PRETO FOSCO	C-400 - 48mm	28mm



EMB. INDIV.	01
EMB. COLET.	04

AÇO INOX
 ZAMAC

APLICAÇÃO	REF.	CÓDIGO
EXTERNA	F-2500	083311

Joy Perfil estreito F-2500

ACABAMENTO	CILINDRO	MÁQUINA
BC- BRANCO	C-400 - 48mm	28mm



EMB. INDIV.	01
EMB. COLET.	04

AÇO INOX
 ZAMAC

APLICAÇÃO	REF.	CÓDIGO
EXTERNA	F-2500	083304

Perfil estreito F-2500

ACABAMENTO	CILINDRO	MÁQUINA
IP- INOX POLIDO	C-400 - 48mm	28mm



EMB. INDIV.	01
EMB. COLET.	40

AÇO INOX
 ZAMAC

APLICAÇÃO	REF.	CÓDIGO
EXTERNA	F-2500	064808

Perfil estreito F-2500

ACABAMENTO	CILINDRO	MÁQUINA
PF- PRETO FOSCO	C-400 - 48mm	28mm



EMB. INDIV.	01
EMB. COLET.	40

AÇO INOX
 ZAMAC

APLICAÇÃO	REF.	CÓDIGO
EXTERNA	F-2500	065126

Perfil estreito F-2500

ACABAMENTO	CILINDRO	MÁQUINA
BC- BRANCO	C-400 - 48mm	28mm



EMB. INDIV.	01
EMB. COLET.	40

AÇO INOX
 ZAMAC

APLICAÇÃO	REF.	CÓDIGO
EXTERNA	F-2500	070618

F-2000 Tetra Simples Roseta Redonda

ACABAMENTO	MÁQUINA
BL- BRONZE LATONADO	40mm



EMB. INDIV.	01
EMB. COLET.	04

AÇO
 ZAMAC
 LATÃO

APLICAÇÃO	REF.	CÓDIGO
EXTERNA	F-2000	041359

F-2000 Tetra Simples Roseta Redonda

ACABAMENTO	MÁQUINA
IP- INOX POLIDO	40mm



EMB. INDIV.	01
EMB. COLET.	04

AÇO
 ZAMAC
 LATÃO

APLICAÇÃO	REF.	CÓDIGO
EXTERNA	F-2000	025298

F-2000 Tetra Simples Roseta Redonda

ACABAMENTO	MÁQUINA
PF- PRETO FOSCO	40mm



EMB. INDIV.	01
EMB. COLET.	04

AÇO
 ZAMAC
 LATÃO

APLICAÇÃO	REF.	CÓDIGO
EXTERNA	F-2000	025267

F-2000 Tetra Simples Roseta Redonda

ACABAMENTO	MÁQUINA
ZLO- ZAMAC LAT. OXID	40mm



EMB. INDIV.	01
EMB. COLET.	04

AÇO
 ZAMAC
 LATÃO

APLICAÇÃO	REF.	CÓDIGO
EXTERNA	F-2000	025328

F-2000 Tetra Simples Roseta Redonda

ACABAMENTO	MÁQUINA
CRE-CRO. ESCOVADO	40mm



EMB. INDIV.	01
EMB. COLET.	04

AÇO
 ZAMAC
 LATÃO

APLICAÇÃO	REF.	CÓDIGO
EXTERNA	F-2000	071578

F-2000 Tetra Dupla Roseta Redonda

ACABAMENTO	MÁQUINA
BL- BRONZE LATONADO	40mm



EMB. INDIV.	01
EMB. COLET.	04

AÇO
 ZAMAC
 LATÃO

APLICAÇÃO	REF.	CÓDIGO
EXTERNA	F-2000	041380

F-2000 Tetra Dupla Roseta Redonda

ACABAMENTO	MÁQUINA
IP- INOX POLIDO	40mm



EMB. INDIV.	01
EMB. COLET.	04

AÇO
 ZAMAC
 LATÃO

APLICAÇÃO	REF.	CÓDIGO
EXTERNA	F-2000	029340

F-2000 Tetra Dupla Roseta Redonda

ACABAMENTO	MÁQUINA
PF- PRETO FOSCO	40mm



EMB. INDIV.	01
EMB. COLET.	04

AÇO
 ZAMAC
 LATÃO

APLICAÇÃO	REF.	CÓDIGO
EXTERNA	F-2000	029326

F-2000 Tetra Dupla Roseta Redonda

ACABAMENTO	MÁQUINA
ZLO- ZAMAC LAT. OXID	40mm



EMB. INDIV.	01
EMB. COLET.	04

AÇO
 ZAMAC
 LATÃO

APLICAÇÃO	REF.	CÓDIGO
EXTERNA	F-2000	029319

F-2000 Tetra Dupla Roseta Redonda

ACABAMENTO	MÁQUINA
CRE-CRO. ESCOVADO	40mm



EMB. INDIV.	01
EMB. COLET.	04

AÇO
 ZAMAC
 LATÃO

APLICAÇÃO	REF.	CÓDIGO
EXTERNA	F-2000	071585

F-2000 Tetra Simples Roseta Quadrada

ACABAMENTO	MÁQUINA
BL- BRONZE LATONADO	40mm



EMB. INDIV.	01
EMB. COLET.	04

AÇO
 ZAMAC
 LATÃO

APLICAÇÃO	REF.	CÓDIGO
EXTERNA	F-2000	071264

F-2000 Tetra Simples Roseta Quadrada

ACABAMENTO	MÁQUINA
CR- CROMADO	40mm



EMB. INDIV.	01
EMB. COLET.	04

AÇO
 ZAMAC
 LATÃO

APLICAÇÃO	REF.	CÓDIGO
EXTERNA	F-2000	071240

Trava de Segurança

F-2000 Tetra Simples Roseta Quadrada

ACABAMENTO	MÁQUINA
CRE-CRO. ESCOVADO	40mm



EMB. INDIV.	01
EMB. COLET.	04

AÇO
 ZAMAC
 LATÃO

APLICAÇÃO	REF.	CÓDIGO
EXTERNA	F-2000	071592

F-2000 Tetra Dupla Roseta Quadrada

ACABAMENTO	MÁQUINA
BL- BRONZE LATONADO	40mm



EMB. INDIV.	01
EMB. COLET.	04

AÇO
 ZAMAC
 LATÃO

APLICAÇÃO	REF.	CÓDIGO
EXTERNA	F-2000	071295

F-2000 Tetra Dupla Roseta Quadrada

ACABAMENTO	MÁQUINA
CR- CROMADO	40mm



EMB. INDIV.	01
EMB. COLET.	04

AÇO
 ZAMAC
 LATÃO

APLICAÇÃO	REF.	CÓDIGO
EXTERNA	F-2000	071271

F-2000 Tetra Dupla Roseta Quadrada

ACABAMENTO	MÁQUINA
CRE-CRO. ESCOVADO	40mm



EMB. INDIV.	01
EMB. COLET.	04

AÇO
 ZAMAC
 LATÃO

APLICAÇÃO	REF.	CÓDIGO
EXTERNA	F-2000	071608

F-2000 Simples Roseta Redonda BL

ACABAMENTO	MÁQUINA
BL-BRONZE LATONADO	40mm



EMB. INDIV.	05
EMB. COLET.	05

AÇO / LATÃO
 ZAMAC

APLICAÇÃO	REF.	CÓDIGO
EXTERNA	F-2000	041410

Trava de Segurança encartelada com 2 chaves tetra

F-2000 Simples Roseta Redonda IP

ACABAMENTO	MÁQUINA
IP- INOX POLIDO	40mm



EMB. INDIV.	05
EMB. COLET.	05

AÇO / LATÃO
 ZAMAC

APLICAÇÃO	REF.	CÓDIGO
EXTERNA	F-2000	025526

Trava de Segurança encartelada com 2 chaves tetra

F-2000 Simples Roseta Redonda PF

ACABAMENTO	MÁQUINA
PF- PRETO FOSCO	40mm



EMB. INDIV.	05
EMB. COLET.	05

AÇO / LATÃO
 ZAMAC

APLICAÇÃO	REF.	CÓDIGO
EXTERNA	F-2000	025502

Trava de Segurança encartelada com 2 chaves tetra

F-2000 Simples Roseta Redonda CRE

ACABAMENTO	MÁQUINA
CRE-CRO. ESCOVADO	40mm



EMB. INDIV.	05
EMB. COLET.	05

AÇO / LATÃO
 ZAMAC

APLICAÇÃO	REF.	CÓDIGO
EXTERNA	F-2000	071615

Trava de Segurança encartelada com 2 chaves tetra

F-2000 Simples Roseta Redonda ZLO

ACABAMENTO	MÁQUINA
ZLO- ZAMAC LAT. OXID	40mm



EMB. INDIV.	05
EMB. COLET.	05

AÇO / LATÃO
 ZAMAC

APLICAÇÃO	REF.	CÓDIGO
EXTERNA	F-2000	025496

Trava de Segurança encartelada com 2 chaves tetra

F-2000 Simples Roseta Redonda BC

ACABAMENTO	MÁQUINA
BC- BRANCO	40mm



EMB. INDIV.	05
EMB. COLET.	05

AÇO / LATÃO
 ZAMAC

APLICAÇÃO	REF.	CÓDIGO
EXTERNA	F-2000	070625

Trava de Segurança encartelada com 2 chaves tetra

Trava de Segurança

F-2000 Dupla Roseta Redonda BL

ACABAMENTO	MÁQUINA
BL-BRONZE LATONADO	40mm



EMB. INDIV.	05
EMB. COLET.	05

AÇO / LATÃO
 ZAMAC

APLICAÇÃO	REF.	CÓDIGO
EXTERNA	F-2000	041441

Trava de Segurança encartelada com 4 chaves tetra

F-2000 Dupla Roseta Redonda IP

ACABAMENTO	MÁQUINA
IP- INOX POLIDO	40mm



EMB. INDIV.	05
EMB. COLET.	05

AÇO / LATÃO
 ZAMAC

APLICAÇÃO	REF.	CÓDIGO
EXTERNA	F-2000	025564

Trava de Segurança encartelada com 4 chaves

F-2000 Dupla Roseta Redonda PF

ACABAMENTO	MÁQUINA
PF- PRETO FOSCO	40mm



EMB. INDIV.	05
EMB. COLET.	05

AÇO / LATÃO
 ZAMAC

APLICAÇÃO	REF.	CÓDIGO
EXTERNA	F-2000	025540

Trava de Segurança encartelada com 4 chaves

F-2000 Dupla Roseta Redonda CRE

ACABAMENTO	MÁQUINA
CRE-CRO. ESCOVADO	40mm



EMB. INDIV.	05
EMB. COLET.	05

AÇO / LATÃO
 ZAMAC

APLICAÇÃO	REF.	CÓDIGO
EXTERNA	F-2000	071622

Trava de Segurança encartelada com 4 chaves tetra

F-2000 Dupla Roseta Redonda ZLO

ACABAMENTO	MÁQUINA
ZLO- ZAMAC LAT. OXID	40mm



EMB. INDIV.	05
EMB. COLET.	05

AÇO / LATÃO
 ZAMAC

APLICAÇÃO	REF.	CÓDIGO
EXTERNA	F-2000	025533

Trava de Segurança encartelada com 4 chaves

F-2000 Dupla Roseta Redonda BC

ACABAMENTO	MÁQUINA
BC- BRANCO	40mm



EMB. INDIV.	05
EMB. COLET.	05

AÇO / LATÃO
 ZAMAC

APLICAÇÃO	REF.	CÓDIGO
EXTERNA	F-2000	070632

Trava de Segurança encartelada com 4 chaves tetra

F-2000 Simples Roseta Quadrada BL

ACABAMENTO	MÁQUINA
BL-BRONZE LATONADO	40mm



EMB. INDIV.	05
EMB. COLET.	05

AÇO / LATÃO
 ZAMAC

APLICAÇÃO	REF.	CÓDIGO
EXTERNA	F-2000	071363

Trava de Segurança encartelada com 2 chaves tetra

F-2000 Simples Roseta Quadrada CR

ACABAMENTO	MÁQUINA
CR- CROMADO	40mm



EMB. INDIV.	05
EMB. COLET.	05

AÇO / LATÃO
 ZAMAC

APLICAÇÃO	REF.	CÓDIGO
EXTERNA	F-2000	071349

Trava de Segurança encartelada com 2 chaves tetra

F-2000 Simples Roseta Quadrada CRE

ACABAMENTO	MÁQUINA
CRE-CRO. ESCOVADO	40mm



EMB. INDIV.	05
EMB. COLET.	05

AÇO / LATÃO
 ZAMAC

APLICAÇÃO	REF.	CÓDIGO
EXTERNA	F-2000	071639

Trava de Segurança encartelada com 2 chaves tetra

F-2000 Dupla Roseta Quadrada BL

ACABAMENTO	MÁQUINA
BL-BRONZE LATONADO	40mm



EMB. INDIV.	05
EMB. COLET.	05

AÇO / LATÃO
 ZAMAC

APLICAÇÃO	REF.	CÓDIGO
EXTERNA	F-2000	071394

Trava de Segurança encartelada com 4 chaves tetra

F-2000 Dupla Roseta Quadrada CR

ACABAMENTO	MÁQUINA
CR- CROMADO	40mm



EMB. INDIV.	05
EMB. COLET.	05

AÇO / LATÃO
 ZAMAC

APLICAÇÃO	REF.	CÓDIGO
EXTERNA	F-2000	071370

Trava de Segurança encartelada com 4 chaves tetra

F-2000 Dupla Roseta Quadrada CRE

ACABAMENTO	MÁQUINA
CRE-CRO. ESCOVADO	40mm



EMB. INDIV.	05
EMB. COLET.	05

AÇO / LATÃO
 ZAMAC

APLICAÇÃO	REF.	CÓDIGO
EXTERNA	F-2000	071646

Trava de Segurança encartelada com 4 chaves tetra

Máquinas 40 / S40 / 55mm

Máquina Fech. 40mm Canto Arredondado

ACABAMENTO	CILINDRO	MÁQUINA
IP- INOX POLIDO	C-400 - 48mm	40mm



EMB. INDIV.	01
EMB. COLET.	25

APLIC.	REF.	CÓDIGO
EXTERNA	F-2610	081171
INTERNA	F-2710	081188
BANHO	F-2810	081195

AÇO / ZAMAC

Máquina Fech. S40mm Canto Arredondado

ACABAMENTO	CILINDRO	MÁQUINA
IP- INOX POLIDO	C-700 - 56mm	S40mm



EMB. INDIV.	01
EMB. COLET.	25

APLIC.	REF.	CÓDIGO
EXTERNA	F-4610	046712
INTERNA	F-4710	046729
BANHO	F-4810	046736

AÇO / ZAMAC

Máquina Fech. S40mm Canto Arredondado

ACABAMENTO	CILINDRO	MÁQUINA
PF- PRETO FOSCO	C-700 - 56mm	S40mm



EMB. INDIV.	01
EMB. COLET.	25

APLIC.	REF.	CÓDIGO
EXTERNA	F-4610	046774
INTERNA	F-4710	046781
BANHO	F-4810	046798

AÇO / ZAMAC

Máquina Fech. 55mm Canto Arredondado

ACABAMENTO	CILINDRO	MÁQUINA
IP- INOX POLIDO	C-700 - 56mm	55mm



EMB. INDIV.	01
EMB. COLET.	25

APLIC.	REF.	CÓDIGO
EXTERNA	F-3610	046743
INTERNA	F-3710	046750
BANHO	F-3810	046767

AÇO / ZAMAC

Máquina Fech. 55mm Canto Arredondado

ACABAMENTO	CILINDRO	MÁQUINA
PF- PRETO FOSCO	C-700 - 56mm	55mm



EMB. INDIV.	01
EMB. COLET.	25

APLIC.	REF.	CÓDIGO
EXTERNA	F-3610	046804
INTERNA	F-3710	046811
BANHO	F-3810	046828

AÇO / ZAMAC

Máquina Fechadura S40mm Canto Reto

ACABAMENTO	CILINDRO	MÁQUINA
IP- INOX POLIDO	C-700 - 56mm	S40mm



EMB. INDIV.	01
EMB. COLET.	25

APLIC.	REF.	CÓDIGO
EXTERNA	F-4600	024673
INTERNA	F-4700	024710
BANHO	F-4800	024864

AÇO / ZAMAC / INOX

Máquina Fechadura S40mm Canto Reto

ACABAMENTO	CILINDRO	MÁQUINA
PF- PRETO FOSCO	C-400 - 48mm	S40mm



EMB. INDIV.	01
EMB. COLET.	25

APLIC.	REF.	CÓDIGO
EXTERNA	F-4600	024680

AÇO / ZAMAC / INOX

Máquina Fechadura S40mm Canto Reto

ACABAMENTO	CILINDRO	MÁQUINA
PF- PRETO FOSCO	C-700 - 56mm	S40mm



EMB. INDIV.	01
EMB. COLET.	25

APLIC.	REF.	CÓDIGO
EXTERNA	F-4600	024697
INTERNA	F-4700	024703
BANHO	F-4800	024857

AÇO / ZAMAC / INOX

Máquina Fechadura 55mm Canto Reto

ACABAMENTO	CILINDRO	MÁQUINA
IP- INOX POLIDO	C-400 - 48mm	S40mm



EMB. INDIV.	01
EMB. COLET.	25

APLIC.	REF.	CÓDIGO
EXTERNA	F-3600	020811

AÇO / ZAMAC / INOX

Máquina Fechadura 55mm Canto Reto

ACABAMENTO	CILINDRO	MÁQUINA
PF- PRETO FOSCO	C-400 - 48mm	55mm



EMB. INDIV.	01
EMB. COLET.	04

APLIC.	REF.	CÓDIGO
EXTERNA	F-3600	020828

AÇO / ZAMAC / INOX

Máquina Fechadura 55mm Canto Reto

ACABAMENTO	CILINDRO	MÁQUINA
PF- PRETO FOSCO	C-700 - 56mm	55mm



EMB. INDIV.	01
EMB. COLET.	25

APLIC.	REF.	CÓDIGO
EXTERNA	F-3600	020835
INTERNA	F-3700	020842
BANHO	F-3800	020866

AÇO / ZAMAC / INOX

Máquina Fechadura 55mm Canto Reto

ACABAMENTO	CILINDRO	MÁQUINA
IP- INOX POLIDO	C-700 - 56mm	55mm



EMB. INDIV.	01
EMB. COLET.	25

APLIC.	REF.	CÓDIGO
EXTERNA	F-3600	056834
INTERNA	F-3700	020859
BANHO	F-3800	020873

AÇO / ZAMAC / INOX

Cilindro para Fechadura C-400

ACABAMENTO	CILINDRO	COMP.
CR- CROMADO	C-400	48mm



EMB. INDIV.	10
EMB. COLET.	20

ZAMAC ALUMINIO

APLICAÇÃO	REF.	CÓDIGO
EXTERNA	C400	054236

Cilindro para Fechadura C-400

ACABAMENTO	CILINDRO	COMP.
PF- PRETO FOSCO	C-400	48mm



EMB. INDIV.	10
EMB. COLET.	20

ZAMAC ALUMINIO

APLICAÇÃO	REF.	CÓDIGO
EXTERNA	C400	054243

Cilindro para Fechadura C-700

ACABAMENTO	CILINDRO	COMP.
CR- CROMADO	C-700	56mm



EMB. INDIV.	10
EMB. COLET.	20

ZAMAC ALUMINIO

APLICAÇÃO	REF.	CÓDIGO
EXTERNA	C700	054250

Cilindro para Fechadura C-700

ACABAMENTO	CILINDRO	COMP.
PF- PRETO FOSCO	C-700	56mm



EMB. INDIV.	10
EMB. COLET.	20

ZAMAC ALUMINIO

APLICAÇÃO	REF.	CÓDIGO
EXTERNA	C700	054267

Cilindro Tetra para Fechadura C-1200

ACABAMENTO	CILINDRO	COMP.
CR- CROMADO	C-1200	56mm



EMB. INDIV.	10
EMB. COLET.	20

ZAMAC ALUMINIO

APLICAÇÃO	REF.	CÓDIGO
EXTERNA	C-1200	046972

Cilindro Tetra para Fechadura C-1200

ACABAMENTO	CILINDRO	COMP.
PF- PRETO FOSCO	C-1200	56mm



EMB. INDIV.	10
EMB. COLET.	20

ZAMAC ALUMINIO

APLICAÇÃO	REF.	CÓDIGO
EXTERNA	F-1200	046965

Chave Gorge Interna F-3710 (N 1)

ACABAMENTO	REF. COMERC.
ZI- ZINCADO	F-3710 N1



EMB. INDIV.	20
EMB. COLET.	20

ZAMAC

APLICAÇÃO	REF.	CÓDIGO
INTERNA	F-3710 N1	029944

Chave para fechaduras de 40mm / S40mm

Chave Gorge Interna F-3710 (N 2)

ACABAMENTO	REF. COMERC.
ZI- ZINCADO	F-3710 N 2



EMB. INDIV.	20
EMB. COLET.	20

ZAMAC

APLICAÇÃO	REF.	CÓDIGO
INTERNA	F-3710 N2	029951

Chave para fechaduras de 40mm / S40mm

Chave Gorge Interna F-3710 (N 3)

ACABAMENTO	REF. COMERC.
ZI- ZINCADO	F-3710 N 3



EMB. INDIV.	20
EMB. COLET.	20

ZAMAC

APLICAÇÃO	REF.	CÓDIGO
INTERNA	F-3710 N3	029968

Chave para fechaduras de 40mm / S40mm

Chave Gorge Interna F-3710 (N 4)

ACABAMENTO	REF. COMERC.
ZI- ZINCADO	F-3710 N 4



EMB. INDIV.	20
EMB. COLET.	20

ZAMAC

APLICAÇÃO	REF.	CÓDIGO
INTERNA	F-3710 N4	029975

Chave para fechaduras de 40mm / S40mm

Chave Gorge Interna F-3710 (N 5)

ACABAMENTO	REF. COMERC.
ZI- ZINCADO	F-3710 N 5



EMB. INDIV.	20
EMB. COLET.	20

ZAMAC

APLICAÇÃO	REF.	CÓDIGO
INTERNA	F-3710 N5	057541

Chave para fechaduras de 40mm / S40mm

Chave Gorge Interna F-3710A (N 1)

ACABAMENTO	REF. COMERC.
NI- NIQUELADO	F-3710A N1



EMB. INDIV.	20
EMB. COLET.	20

ZAMAC

APLICAÇÃO	REF.	CÓDIGO
INTERNA	F-3710A	053161

Chave para fechaduras de 55mm

Chave Gorge Interna F-3710A (N 2)

ACABAMENTO	REF. CO-
NI- NIQUELADO	F-3710A N2

EMB. INDIV.	20
EMB. COLET.	20

ZAMAC

APLICAÇÃO	REF.	CÓDIGO
INTERNA	F-3710A	053178

Chave para fechaduras de 55mm

Chave Gorge Interna F-3710A (N 3)

ACABAMENTO	REF. CO-
NI- NIQUELADO	F-3710A N3

EMB. INDIV.	20
EMB. COLET.	20

ZAMAC

APLICAÇÃO	REF.	CÓDIGO
INTERNA	F-3710A	053185

Chave para fechaduras de 55mm

Chave Gorge Interna F-3710A (N 4)

ACABAMENTO	REF. CO-
NI- NIQUELADO	F-3710A N4

EMB. INDIV.	20
EMB. COLET.	20

ZAMAC

APLICAÇÃO	REF.	CÓDIGO
INTERNA	F-3710A	053192

Chave para fechaduras de 55mm

Chave Gorge Interna F-3710A (N 5)

ACABAMENTO	REF. CO-
NI- NIQUELADO	F-3710A N5

EMB. INDIV.	20
EMB. COLET.	20

ZAMAC

APLICAÇÃO	REF.	CÓDIGO
INTERNA	F-3710A	053208

Chave para fechaduras de 55mm

Chave Gorge Interna F-3710A (N 6)

ACABAMENTO	REF. CO-
NI- NIQUELADO	F-3710A N6

EMB. INDIV.	20
EMB. COLET.	20

ZAMAC

APLICAÇÃO	REF.	CÓDIGO
INTERNA	F-3710A	053215

Chave para fechaduras de 55mm

Chave para Fechadura Tetra

ACABAMENTO	REF. CO-
NI- NIQUELADO	C1001

EMB. INDIV.	10
EMB. COLET.	50

ZAMAC

APLICAÇÃO	REF.	CÓDIGO
EXTERNA	C1001	079956

Maçaneta Inox Premium 86617

ACABAMENTOMAÇANETA
CR- CROMADO ALAVANCA

EMB. INDIV.	10
EMB. COLET.	10

ZAMAC

APLICAÇÃO	REF.	CÓDIGO
PORTA DE BATER	86617	072353

Maçaneta Alavanca Inox Premium

Maçaneta Inox 86548

ACABAMENTOMAÇANETA
CR- CROMADO ALAVANCA

EMB. INDIV.	10
EMB. COLET.	10

ZAMAC

APLICAÇÃO	REF.	CÓDIGO
PORTA DE BATER	86548	028008

Maçaneta Alavanca Inox

Maçaneta Galaxy 86616

ACABAMENTOMAÇANETA
CR- CROMADO ALAVANCA

EMB. INDIV.	10
EMB. COLET.	10

ZAMAC

APLICAÇÃO	REF.	CÓDIGO
PORTA DE BATER	86616	072438

Maçaneta Alavanca Galaxy

Maçaneta Colonial 86035

ACABAMENTO	MAÇANETA
ZLO- ZAMAC LAT. OXID	ALAVANCA

EMB. INDIV.	10
EMB. COLET.	10

ZAMAC

APLICAÇÃO	REF.	CÓDIGO
PORTA DE BATER	86035	027674

Maçaneta Alavanca Colonial

Maçaneta Orion Anatômico 86607

ACABAMENTO	MAÇANETA
BL-BRONZE LATONADO	ALAVANCA

EMB. INDIV.	05
EMB. COLET.	10

ZAMAC

APLICAÇÃO	REF.	CÓDIGO
PORTA DE BATER	86607	057947

Maçaneta Alavanca Anatômico

Maçaneta Orion Anatômico 86607

ACABAMENTOMAÇANETA
CR- CROMADO ALAVANCA

EMB. INDIV.	05
EMB. COLET.	10

ZAMAC

APLICAÇÃO	REF.	CÓDIGO
PORTA DE BATER	86607	062644

Maçaneta Alavanca Anatômico

Maçaneta Golf 86609

ACABAMENTO	MAÇANETA
BL-BRONZE LATONADO	BOLA



EMB. INDIV.	10
EMB. COLET.	10

ZAMAC

APLICAÇÃO	REF.	CÓDIGO
PORTA DE BATER	86609	061302

Maçaneta Bola Golf

Maçaneta Golf 86609

ACABAMENTO	MAÇANETA
CR- CROMADO	BOLA



EMB. INDIV.	10
EMB. COLET.	10

ZAMAC

APLICAÇÃO	REF.	CÓDIGO
PORTA DE BATER	86609	061296

Maçaneta Bola Golf

Maçaneta Colonial 84034

ACABAMENTO	MAÇANETA
ZLO- ZAMAC LAT. OXID	BOLA



EMB. INDIV.	10
EMB. COLET.	10

ALUMINIO

APLICAÇÃO	REF.	CÓDIGO
PORTA DE BATER	84034	027261

Maçaneta Bola Colonial

Maçaneta Bola Quadrada 86537

ACABAMENTO	MAÇANETA
CR- CROMADO	BOLA QUAD.



EMB. INDIV.	05
EMB. COLET.	10

ZAMAC

APLICAÇÃO	REF.	CÓDIGO
PORTA DE BATER	86537	012533

Maçaneta Bola Quadrada

Maçaneta Bola Quadrada Descentr. 86539

ACABAMENTO	MAÇANETA
CR- CROMADO	BOLA QUAD. DES.



EMB. INDIV.	05
EMB. COLET.	10

ZAMAC

APLICAÇÃO	REF.	CÓDIGO
PORTA DE BATER	86539	012540

Maçaneta Bola Quadrada

Maçaneta Galaxy 86616

ACABAMENTO	MAÇANETA
BL-BRONZE LATONADD	ALAVANCA



EMB. INDIV.	05
EMB. COLET.	05

AÇO
ZAMAC

APLICAÇÃO	REF.	CÓDIGO
PORTA DE BATER	86616	069926

Maçaneta Alavanca Galaxy (Encartelada)

Maçaneta Galaxy 86616

ACABAMENTO	MAÇANETA
CR- CROMADO	ALAVANCA



EMB. INDIV.	05
EMB. COLET.	05

AÇO
ZAMAC

APLICAÇÃO	REF.	CÓDIGO
PORTA DE BATER	86616	069919

Maçaneta Alavanca Galaxy (Encartelada)

Maçaneta Home 86615

ACABAMENTO	MAÇANETA
BL-BRONZE LATONADO	ALAVANCA



EMB. INDIV.	05
EMB. COLET.	05

AÇO
ZAMAC

APLICAÇÃO	REF.	CÓDIGO
PORTA DE BATER	86615	067090

Maçaneta Alavanca Home (Encartelada)

Maçaneta Home 86615

ACABAMENTO	MAÇANETA
CR- CROMADO	ALAVANCA



EMB. INDIV.	05
EMB. COLET.	05

AÇO
ZAMAC

APLICAÇÃO	REF.	CÓDIGO
PORTA DE BATER	86615	067083

Maçaneta Alavanca Home (Encartelada)

Maçaneta Inox 86548

ACABAMENTO	MAÇANETA
CR- CROMADO	ALAVANCA



EMB. INDIV.	05
EMB. COLET.	05

ZAMAC

APLICAÇÃO	REF.	CÓDIGO
PORTA DE BATER	86548	032081

Maçaneta Alavanca (Encartelada)

Maçaneta 86542

ACABAMENTO	MAÇANETA
CR- CROMADO	ALAVANCA



EMB. INDIV.	05
EMB. COLET.	05

ZAMAC

APLICAÇÃO	REF.	CÓDIGO
PORTA DE BATER	86542	020262

Maçaneta Alavanca (Encartelada)

Maçaneta Inox Premium 86617

ACABAMENTO	MAÇANETA
CR- CROMADO	ALAVANCA



EMB. INDIV.	05
EMB. COLET.	05

ZAMAC

APLICAÇÃO	REF.	CÓDIGO
PORTA DE BATER	86617	072070

Maçaneta Alavanca Inox Premium (Encartelada)

Maçaneta Colonial 86035

ACABAMENTO	MAÇANETA
ZLO- ZAMAC LAT. OXID	ALAVANCA



EMB. INDIV.	05
EMB. COLET.	05

ZAMAC

APLICAÇÃO	REF.	CÓDIGO
PORTA DE BATER	86035	027810

Maçaneta Alavanca Colonial (Encartelada)

Maçaneta Colonial 84034

ACABAMENTO	MAÇANETA
ZLO- ZAMAC LAT. OXID	BOLA



EMB. INDIV.	05
EMB. COLET.	05

ZAMAC

APLICAÇÃO	REF.	CÓDIGO
PORTA DE BATER	84034	029265

Maçaneta Bola Colonial (Encartelada)

Maçaneta Bola Quadrada 86537

ACABAMENTO	MAÇANETA
CR- CROMADO	BOLA QUADRADA



EMB. INDIV.	05
EMB. COLET.	05

ZAMAC

APLICAÇÃO	REF.	CÓDIGO
PORTA DE BATER	86537	02048

Maçaneta Bola Quadrada (Encartelada)

Maçaneta Bola Quadrada Desc. 86539

ACABAMENTO	MAÇANETA
ZLO- ZAMAC LAT. OXID	BOLA QUAD. DES.



EMB. INDIV.	05
EMB. COLET.	05

ZAMAC

APLICAÇÃO	REF.	CÓDIGO
PORTA DE BATER	86539	029722

Maçaneta Bola Quadrada Desc. (Encartelada)

Maçaneta Anatômica 86607

ACABAMENTO	MAÇANETA
BL-BRONZE LATONADO	ALAVANCA



EMB. INDIV.	05
EMB. COLET.	05

ZAMAC

APLICAÇÃO	REF.	CÓDIGO
PORTA DE BATER	86607	056971

Maçaneta Alavanca Orio Anatomic (Encartelada)

Maçaneta Anatômica 86607

ACABAMENTO MAÇANETA		
CR- CROMADO	ALAVANCA	
	EMB. INDIV.	05
	EMB. COLET.	05
AÇO ZAMAC		
APLICAÇÃO	REF.	CÓDIGO
PORTA DE BATER	86607	056995
Maçaneta Alavanca Orion Anatomic (Encartelada)		

Cilindro para Fechadura C-400 Encartelado

ACABAMENTO	CILINDRO	COMPRI-
CR CROMADO	C-400	48mm
	EMB. INDIV.	05
	EMB. COLET.	05
ZAMAC		
APLICAÇÃO	REF.	CÓDIGO
EXTERNA	C400	057619

Cilindro para Fechadura C-400 Encartelado

ACABAMENTO	CILINDRO	COMPRI-
PF- PRETO FOSCO	C-400	48mm
	EMB. INDIV.	05
	EMB. COLET.	05
ZAMAC		
APLICAÇÃO	REF.	CÓDIGO
EXTERNA	C400	057626

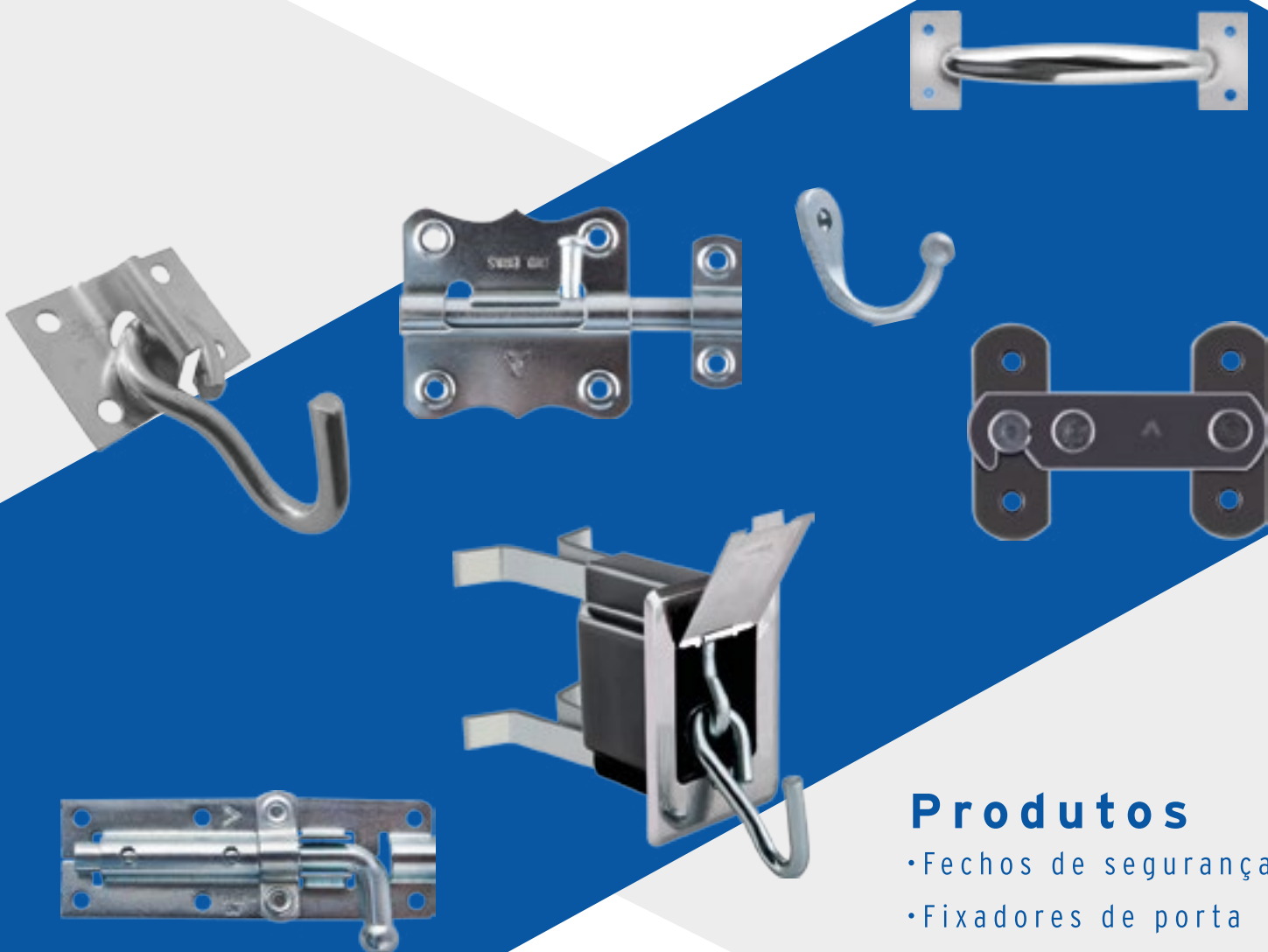

Produtos

- Fechos de segurança
- Fixadores de porta
- Porta cadeados
- Tarjetas
- Tranquetas
- Puxadores
- Ganchos de rede
- Cabides

FICHAS TÉCNICAS FERRAGENS

Utilize o leitor de QR Code para
acessar as fichas técnicas
o ou **CLIQUE AQUI**





Segurança
Dupla trava



Durabilidade
Corpo em Latão
maciço



Resistente
Haste de aço
carbono



70 ANOS
de garantia

*Praticidade e Segurança
na palma da*

MÃO

Utilize o leito de
QR Code para ter
acesso ao material
Digital



DOBRADIÇAS ALIANÇA

Ainda mais segurança
para sua **família**



Utilize o leito de
QR Code para ter
acesso ao material
Digital



Fecho de segurança/Porta - CR

ACABAMENTO	REF.	MATERIAL
CR- Cromado	86572	Aço

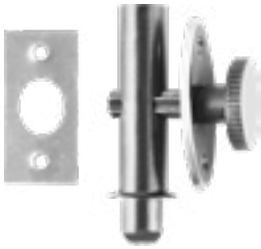

EMB. INDIV.	10
EMB. COLET.	100

CÓDIGO
011321

Fecho de segurança/Porta - ZLO

ACABAMENTO	REF.	MATERIAL
ZLO- Zamac Latão Oxi.	86572	Aço



EMB. INDIV.	10
EMB. COLET.	100

CÓDIGO
035327

Fixador de Porta/Piso - ZI

ACABAMENTO	REF.	MATERIAL
ZI- Zincado	86151/3	Aço/Zamac



EMB. INDIV.	10
EMB. COLET.	100

CÓDIGO
011420

Fixador de Porta/Piso - ZLO

ACABAMENTO	REF.	MATERIAL
ZLO- Zamac Latão Oxi.	86151/3	Aço/Zamac



EMB. INDIV.	10
EMB. COLET.	100

CÓDIGO
035334

Fixador de porta /Rodapé - ZI

ACABAMENTO	REF.	MATERIAL
ZI- Zincado	86151/1	Aço/Zamac



EMB. INDIV.	10
EMB. COLET.	100

CÓDIGO
011406

Fixador de porta /Rodapé - ZLO

ACABAMENTO	REF.	MATERIAL
ZLO- Zamac Latão Oxi.	86151/1	Aço/Zamac



EMB. INDIV.	10
EMB. COLET.	100

CÓDIGO
035419

Porta cadeado - 51mm

ACABAMENTO	REF.	MATERIAL
ZI- Zincado	81114	Aço



EMB. INDIV.	50
EMB. COLET.	1000

CÓDIGO
011352
TAM.
51MM
2,0"

Porta cadeado - 63mm

ACABAMENTO	REF.	MATERIAL
ZI- Zincado	81114	Aço



EMB. INDIV.	50
EMB. COLET.	500

CÓDIGO
011376
TAM.
63MM
2,5"

Porta cadeado - 89mm

ACABAMENTO	REF.	MATERIAL
ZI- Zincado	81114	Aço



EMB. INDIV.	10
EMB. COLET.	150

CÓDIGO
011383
TAM.
89MM
3,5"

Porta cadeado - 114mm

ACABAMENTO	REF.	MATERIAL
ZI- Zincado	81114	Aço



EMB. INDIV.	10
EMB. COLET.	150

CÓDIGO
011390
TAM.
114MM
4,5"

Tarjeta Fio Redondo - 38mm

ACABAMENTO	REF.	MATERIAL
ZI- Zincado	81098	Aço



EMB. INDIV.	50
EMB. COLET.	1000

CÓDIGO
011475
TAM.
38MM
1,5"

Tarjeta Fio Redondo - 51mm

ACABAMENTO	REF.	MATERIAL
ZI- Zincado	81098	Aço



EMB. INDIV.	50
EMB. COLET.	500

CÓDIGO
011482
TAM.
51MM
2,0"

Tarjeta Fio Redondo - 63mm

ACABAMENTO	REF.	MATERIAL
Zl- Zincado	81098	Aço



EMB. INDIV.	50
EMB. COLET.	250

CÓDIGO
011499
TAM.
63MM
2,5"

Tarjeta Fio Redondo - 76mm

ACABAMENTO	REF.	MATERIAL
Zl- Zincado	81098	Aço



EMB. INDIV.	50
EMB. COLET.	250

CÓDIGO
011505
TAM.
76MM
3,0"

Tranqueta - Zl

ACABAMENTO	REF.	MATERIAL
Zl- Zincado	86108/2	Zamac



EMB. INDIV.	20
EMB. COLET.	400

CÓDIGO
011536

Tranqueta - ZLO

ACABAMENTO	REF.	MATERIAL
ZLO- Zamac Latão Oxi.l	86108/2	Zamac



EMB. INDIV.	20
EMB. COLET.	400

CÓDIGO
035402

Tranqueta Suporte c/ Ressalto - Zl

ACABAMENTO	REF.	MATERIAL
Zl- Zincado	86108/3	Zamac



EMB. INDIV.	20
EMB. COLET.	400

CÓDIGO
011550

Tranqueta Bico Virado- Zl

ACABAMENTO	REF.	MATERIAL
Zl- Zincado	86108/4	Zamac



EMB. INDIV.	20
EMB. COLET.	400

CÓDIGO
063863

Tranqueta Bico Virado- ZLO

ACABAMENTO	REF.	MATERIAL
ZLO- Zamac Latão Oxi.l	86108/4	Zamac



EMB. INDIV.	20
EMB. COLET.	400

CÓDIGO
063856

Tranqueta Bico Virado Sup. c/ Ressalto - Zl

ACABAMENTO	REF.	MATERIAL
Zl- Zincado	86108/5	Zamac



EMB. INDIV.	20
EMB. COLET.	400

CÓDIGO
063870

Tranqueta Bico Virado Sup. c/ Ressalto - ZLO

ACABAMENTO	REF.	MATERIAL
ZLO- Zamac Latão Oxi.l	86108/5	Zamac



EMB. INDIV.	20
EMB. COLET.	400

CÓDIGO
063887

Fecho Pedreze Fio Redondo 102mm - Zl

ACABAMENTO	REF.	MATERIAL
Zl- Zincado	81128	Zamac



EMB. INDIV.	10
EMB. COLET.	100

CÓDIGO
011048
TAM.
102MM
4,0"

Fecho Pedreze Fio Redondo 152mm - Zl

ACABAMENTO	REF.	MATERIAL
Zl- Zincado	81128	Zamac



EMB. INDIV.	10
EMB. COLET.	100

CÓDIGO
011055
TAM.
152MM
6,0"

Fecho Janela - ZI

ACABAMENTO	REF.	MATERIAL
ZI- Zincado	8110	Aço



EMB. INDIV.	10
EMB. COLET.	400

CÓDIGO
011024

Fecho Janela - ZLO

ACABAMENTO	REF.	MATERIAL
ZLO- Zamac Latão Oxi.	8110	Aço



EMB. INDIV.	10
EMB. COLET.	400

CÓDIGO
035280

Fecho Móveis 70mm - CT

ACABAMENTO	REF.	MATERIAL
CT-Bicromatizado	81101	Aço



EMB. INDIV.	100
EMB. COLET.	500

CÓDIGO
012052
TAM.
70MM

Fecho Móveis 70mm - CT

ACABAMENTO	REF.	MATERIAL
CT-Bicromatizado	81101	Aço



EMB. INDIV.	30
EMB. COLET.	600

CÓDIGO
028169
TAM.
70MM

Fech. Móveis Cil. de Sobrepor Segr. diversos

ACABAMENTO	REF.	MATERIAL
NI-Niquelado	F1000	Aço/Zamac



EMB. INDIV.	20
EMB. COLET.	20

CÓDIGO
011857
Fechadura Móveis cilindro de sobrepor
F1000 SEGREDOS DIVERSOS

Fech. Móveis Cil. de Sobrepor Segr. único

ACABAMENTO	REF.	MATERIAL
NI-Niquelado	F1000	Aço/Zamac



EMB. INDIV.	20
EMB. COLET.	200

CÓDIGO
035426
Fechadura Móveis cilindro de sobrepor
F1000 SEGREGO ÚNICO

Fech. Móveis Cil. de Sobrepor Segr. diversos

ACABAMENTO	REF.	MATERIAL
NI-Niquelado	F1000	Aço/Zamac



EMB. INDIV.	300
EMB. COLET.	300

CÓDIGO
047757
Fechadura Móveis cilindro de sobrepor
F1000 SEGREDOS DIVERSOS

Fech. Móveis Cil. de Entalhar Segr. diversos

ACABAMENTO	REF.	MATERIAL
NI-Niquelado	F1100	Aço/Zamac



EMB. INDIV.	20
EMB. COLET.	100

CÓDIGO
011864
Fechadura Móveis cilindro de entalhar
F1100 SEGREDOS DIVERSOS

Fecho Móveis de Sobrepor F1172/2 - CT

ACABAMENTO	REF.	MATERIAL
CT-Bicromatizado	F1172/2	Aço



EMB. INDIV.	20
EMB. COLET.	200

CÓDIGO
011918

Fecho Móveis de Embutir F1166/2 - CT

ACABAMENTO	REF.	MATERIAL
CT-Bicromatizado	F1166/2	Aço



EMB. INDIV.	20
EMB. COLET.	200

CÓDIGO
011871

Chave p/ Fechadura Móveis 6174/2 - CT

ACABAMENTO	REF.	MATERIAL
CT-Bicromatizado	6174/2	Zamac



EMB. INDIV.	100
EMB. COLET.	100

CÓDIGO
011703

Ferragens

Roldana Embutir Trilho 86204 - CT

ACABAMENTO	REF.	MATERIAL
CT-Bicromatizado	86204	Zamac



EMB. INDIV.	20
EMB. COLET.	20

CÓDIGO
012427

TAM.
60MM

Puxador p/ Armário de Aço 104mm CR

ACABAMENTO	REF.	MATERIAL
CR-Cromado	86140	Zamac



EMB. INDIV.	20
EMB. COLET.	20

CÓDIGO
012403

TAM.
104MM

Puxador Alça 65mm - 6366/2 - CR

ACABAMENTO	REF.	MATERIAL
CR-Cromado	6366/2	Zamac



EMB. INDIV.	20
EMB. COLET.	20

CÓDIGO
012120

TAM.
65MM

Puxador Alça 102mm - 86127 - CR

ACABAMENTO	REF.	MATERIAL
CR- Cromado	86127	Zamac



EMB. INDIV.	20
EMB. COLET.	20

CÓDIGO
012380

TAM.
102MM

Puxador Alça 120mm - 86127 - CR

ACABAMENTO	REF.	MATERIAL
CR- Cromado	86127	Zamac



EMB. INDIV.	20
EMB. COLET.	20

CÓDIGO
012397

TAM.
120MM

Puxador Botão Concavo 25mm - CR

ACABAMENTO	REF.	MATERIAL
CR- Cromado	86096/2	Zamac



EMB. INDIV.	20
EMB. COLET.	20

CÓDIGO
012281

TAM.
25MM

Puxador Botão Concavo 25mm - ZLO

ACABAMENTO	REF.	MATERIAL
ZLO- Zamac Latão Oxi.	86096/2	Zamac



EMB. INDIV.	20
EMB. COLET.	20

CÓDIGO
035365

TAM.
25MM

Puxador Botão Convexo 25mm - CR

ACABAMENTO	REF.	MATERIAL
CR- Cromado	86097/2	Zamac



EMB. INDIV.	20
EMB. COLET.	20

CÓDIGO
012342

TAM.
25MM

Puxador Botão Convexo 25mm - ZLO

ACABAMENTO	REF.	MATERIAL
ZLO- Zamac Latão Oxi.	86097/2	Zamac



EMB. INDIV.	20
EMB. COLET.	20

CÓDIGO
035372

TAM.
25MM

Armador de Rede Sobrepor 1371 - ZI

ACABAMENTO	REF.	MATERIAL
ZI- Zincado	1371	Aço



EMB. INDIV.	10
EMB. COLET.	50

CÓDIGO
011574

Armador de Rede Sobrepor 1371 - ZP

ACABAMENTO	REF.	MATERIAL
ZP- Zincado Preto	1371	Aço



EMB. INDIV.	10
EMB. COLET.	50

CÓDIGO
011581

Armador de Rede Chumbar 1374/2 - ZI

ACABAMENTO	REF.	MATERIAL
ZI- Zincado	1374/2	Aço



EMB. INDIV.	10
EMB. COLET.	50

CÓDIGO
011604

Imagens meramente ilustrativas

Armador de Rede Chumbar 1374/2 - ZP

ACABAMENTO	REF.	MATERIAL
ZP- Zincado Preto	1374/2	Aço



EMB. INDIV.	10
EMB. COLET.	50

CÓDIGO 011611

Armador de Rede Embutir 7323 - IP

ACABAMENTO	REF.	MATERIAL
IP- Inox Polido	7323	Aço Inox Zamac



EMB. INDIV.	1
EMB. COLET.	32

CÓDIGO 011673

Armador de Rede Embutir 6323 - ZLO

ACABAMENTO	REF.	MATERIAL
ZLO- Zamac Latão Oxi.	6323	Aço Inox Zamac



EMB. INDIV.	1
EMB. COLET.	32

CÓDIGO 011642

Espelho Armador de Rede Inox 7323 - IP

ACABAMENTO	REF.	MATERIAL
IP- Inox Polido	7323	Aço Inox



EMB. INDIV.	10
EMB. COLET.	10

CÓDIGO 027964

Espelho Armador de Rede Colonial 6323 - ZLO

ACABAMENTO	REF.	MATERIAL
ZLO- Zamac Latão Oxi.	6323	Zamac



EMB. INDIV.	10
EMB. COLET.	10

CÓDIGO 027971

Gancho Avul. p/ Arm. de rede Batom 1375 - ZI

ACABAMENTO	REF.	MATERIAL
ZI- Zincado	1375	Aço



EMB. INDIV.	10
EMB. COLET.	10

CÓDIGO 066826

Arm. de Rede Tipo Batom/Chumbar 1375-21

ACABAMENTO	REF.	MATERIAL
ZI- Zincado	1375	Aço/Zamac



EMB. INDIV.	01
EMB. COLET.	10

CÓDIGO 066031

Cabide Simples Gancho Pequeno 6398/1-21

ACABAMENTO	REF.	MATERIAL
ZI- Zincado	6398/1	Zamac



EMB. INDIV.	20
EMB. COLET.	1600

CÓDIGO 010096

Cabide Simples Gancho Grande 6398/3-21

ACABAMENTO	REF.	MATERIAL
ZI- Zincado	6398/3	Zamac



EMB. INDIV.	20
EMB. COLET.	800

CÓDIGO 010119

Cabide Simples Gancho Duplo 6398/5-21

ACABAMENTO	REF.	MATERIAL
ZI- Zincado	6398/5	Zamac



EMB. INDIV.	20
EMB. COLET.	200

CÓDIGO 010133

Dobradiça Pino Bola e Anel

ACABAMENTO	REF.	MATERIAL
BL-BRONZE LATONADO	81500A	AÇO CARBONO



EMB. BLISTER	10
EMB. IND.	10

CÓDIGO INDIV. 087449
CÓDIGO COLET. 087654

Chapa de 1,50mm
3.1/2" X 2.1/2"

Dobradiça Pino Bola e Anel

ACABAMENTO	REF.	MATERIAL
ZI-ZINCADO	81500A	AÇO CARBONO

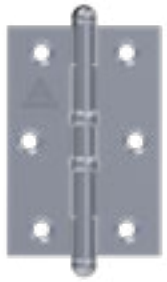

EMB. BLISTER	10
EMB. IND.	10

CÓDIGO INDIV. 087425
CÓDIGO COLET. 087630

Chapa de 1,50mm
3.1/2" X 2.1/2"

Dobradiça Pino Bola e Anel

ACABAMENTO	REF.	MATERIAL
NI-NIQUELADO	81500A	AÇO CARBONO



EMB. BLISTER	10
EMB. IND.	10

CÓDIGO INDIV. 087432
CÓDIGO COLET. 087647

Chapa de 1,50mm
3.1/2" X 2.1/2"

Dobradiça Pino Bola e Anel

ACABAMENTO	REF.	MATERIAL
BL-BRONZE LATONADO	81500A	AÇO CARBONO

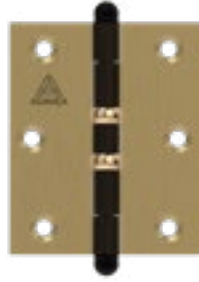

EMB. BLISTER	10
EMB. IND.	10

CÓDIGO INDIV. 087418
CÓDIGO COLET. 087623

Chapa de 1,50mm
3" X 2.1/2"

Dobradiça Pino Bola e Anel

ACABAMENTO	REF.	MATERIAL
ZI-ZINCADO	81500A	AÇO CARBONO



EMB. BLISTER	10
EMB. IND.	10

CÓDIGO INDIV. 087395
CÓDIGO COLET. 087609

Chapa de 1,50mm
3" X 2.1/2"

Dobradiça Pino Bola e Anel

ACABAMENTO	REF.	MATERIAL
NI-NIQUELADO	81500A	AÇO CARBONO



EMB. BLISTER	10
EMB. IND.	10

CÓDIGO INDIV. 087401
CÓDIGO COLET. 087616

Chapa de 1,50mm
3" X 2.1/2"

Dobradiça Pino Bola

ACABAMENTO	REF.	MATERIAL
BL-BRONZE LATONADO	81500B	AÇO CARBONO



EMB. BLISTER	10
EMB. IND.	10

CÓDIGO INDIV. 087388
CÓDIGO COLET. 087593

Chapa de 1,50mm
3.1/2" X 2.1/2"

Dobradiça Pino Bola

ACABAMENTO	REF.	MATERIAL
ZI-ZINCADO	81500B	AÇO CARBONO



EMB. BLISTER	10
EMB. IND.	10

CÓDIGO INDIV. 087364
CÓDIGO COLET. 087579

Chapa de 1,50mm
3.1/2" X 2.1/2"

Dobradiça Pino Bola

ACABAMENTO	REF.	MATERIAL
NI-NIQUELADO	81500B	AÇO CARBONO



EMB. BLISTER	10
EMB. IND.	10

CÓDIGO INDIV. 087371
CÓDIGO COLET. 087586

Chapa de 1,50mm
3.1/2" X 2.1/2"

Dobradiça Pino Bola

ACABAMENTO	REF.	MATERIAL
BL-BRONZE LATONADO	81500B	AÇO CARBONO



EMB. BLISTER	10
EMB. IND.	10

CÓDIGO INDIV. 087357
CÓDIGO COLET. 087562

Chapa de 1,50mm
3" X 2.1/2"

Dobradiça Pino Bola

ACABAMENTO	REF.	MATERIAL
ZI-ZINCADO	81500B	AÇO CARBONO



EMB. BLISTER	10
EMB. IND.	10

CÓDIGO INDIV. 087333
CÓDIGO COLET. 087548

Chapa de 1,50mm
3" X 2.1/2"

Dobradiça Pino Bola

ACABAMENTO	REF.	MATERIAL
NI-NIQUELADO	81500B	AÇO CARBONO



EMB. BLISTER	10
EMB. IND.	10

CÓDIGO INDIV. 087340
CÓDIGO COLET. 087555

Chapa de 1,50mm
3" X 2.1/2"

Dobradiça Pino Reversível

ACABAMENTO	REF.	MATERIAL
BL-BRONZE LATONADO	81500C	AÇO CARBONO



EMB. BLISTER	10
EMB. IND.	10

CÓDIGO INDIV. 087258
CÓDIGO COLET. 087463

Chapa de 1,20mm
3 1/2" X 2. 1/2"

Dobradiça Pino Reversível

ACABAMENTO	REF.	MATERIAL
ZI-ZINCADO	81500C	AÇO CARBONO



EMB. BLISTER	10
EMB. IND.	10

CÓDIGO INDIV. 087241
CÓDIGO COLET. 087456

Chapa de 1,20mm
3 1/2" X 2. 1/2"

Dobradiça Pino Reversível

ACABAMENTO	REF.	MATERIAL
NI-NIQUELADO	81500C	AÇO CARBONO



EMB. BLISTER	10
EMB. IND.	10

CÓDIGO INDIV. 087265
CÓDIGO COLET. 087470

Chapa de 1,20mm
3 1/2" X 2. 1/2"

Dobradiça Pino Reversível

ACABAMENTO	REF.	MATERIAL
BL-BRONZE LATONADO	81500C	AÇO CARBONO



EMB. BLISTER	10
EMB. IND.	10

CÓDIGO INDIV. 087289
CÓDIGO COLET. 087494

Chapa de 1,50mm
3 1/2" X 2. 1/2"

Dobradiça Pino Reversível

ACABAMENTO	REF.	MATERIAL
ZI-ZINCADO	81500C	AÇO CARBONO

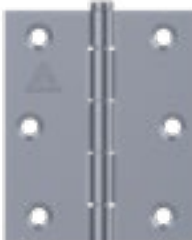

EMB. BLISTER	10
EMB. IND.	10

CÓDIGO INDIV. 087272
CÓDIGO COLET. 087487

Chapa de 1,50mm
3 1/2" X 2. 1/2"

Dobradiça Pino Reversível

ACABAMENTO	REF.	MATERIAL
NI-NIQUELADO	81500C	AÇO CARBONO



EMB. BLISTER	10
EMB. IND.	10

CÓDIGO INDIV. 087296
CÓDIGO COLET. 087500

Chapa de 1,50mm
3 1/2" X 2. 1/2"

Dobradiça Pino Reversível

ACABAMENTO	REF.	MATERIAL
BL-BRONZE LATONADO	81500C	AÇO CARBONO



EMB. BLISTER	10
EMB. IND.	10

CÓDIGO INDIV. 087319
CÓDIGO COLET. 087524

Chapa de 1,50mm
3" X 2. 1/2"

Dobradiça Pino Reversível

ACABAMENTO	REF.	MATERIAL
ZI-ZINCADO	81500C	AÇO CARBONO



EMB. BLISTER	10
EMB. IND.	10

CÓDIGO INDIV. 087302
CÓDIGO COLET. 087517

Chapa de 1,50mm
3" X 2. 1/2"

Dobradiça Pino Reversível

ACABAMENTO	REF.	MATERIAL
NI-NIQUELADO	81500C	AÇO CARBONO



EMB. BLISTER	10
EMB. IND.	10

CÓDIGO INDIV. 087326
CÓDIGO COLET. 087531

Chapa de 1,50mm
3" X 2. 1/2"

Cadeado Latão A-20

ACABAMENTO	REF.	MATERIAL
LT-LATÃO	A20	LATÃO/AÇO CARBONO
		EMB. INDIV.
		10
		EMB. COLET.
		10
CÓDIGO IND. 087678		

Cadeado Latão A-25

ACABAMENTO	REF.	MATERIAL
LT-LATÃO	A25	LATÃO/AÇO CARBONO
		EMB. INDIV.
		10
		EMB. COLET.
		10
CÓDIGO IND. 087685		

Cadeado Latão A-30

ACABAMENTO	REF.	MATERIAL
LT-LATÃO	A30	LATÃO/AÇO CARBONO
		EMB. INDIV.
		10
		EMB. COLET.
		10
CÓDIGO IND. 087692		

Cadeado Latão A-35

ACABAMENTO	REF.	MATERIAL
LT-LATÃO	A35	LATÃO/AÇO CARBONO
		EMB. INDIV.
		5
		EMB. COLET.
		5
CÓDIGO IND. 087708		

Cadeado Latão A-40

ACABAMENTO	REF.	MATERIAL
LT-LATÃO	A40	LATÃO/AÇO CARBONO
		EMB. INDIV.
		5
		EMB. COLET.
		5
CÓDIGO IND. 087715		

Cadeado Latão A-45

ACABAMENTO	REF.	MATERIAL
LT-LATÃO	A45	LATÃO/AÇO CARBONO
		EMB. INDIV.
		5
		EMB. COLET.
		5
CÓDIGO IND. 087722		

Cadeado Latão A-50

ACABAMENTO	REF.	MATERIAL
LT-LATÃO	A50	LATÃO/AÇO CARBONO
		EMB. INDIV.
		5
		EMB. COLET.
		5
CÓDIGO IND. 087739		

Cartela - Fecho Móveis 70mm - CT

ACABAMENTO	REF.	MATERIAL
CT-Bicromatizado	81101	Zamac



EMB. INDIV.	5
EMB. COLET.	5

CÓDIGO
067793

TAM.
70MM

Cartela - Fecho Pedreze Fio Red. 102mm - ZI

ACABAMENTO	REF.	MATERIAL
ZI- Zincado	81128	Zamac



EMB. INDIV.	5
EMB. COLET.	5

CÓDIGO
067809

TAM.
102MM
4,0"

Cartela - Fecho Pedreze Fio Red. 152mm - ZI

ACABAMENTO	REF.	MATERIAL
ZI- Zincado	81128	Zamac



EMB. INDIV.	5
EMB. COLET.	5

CÓDIGO
067816

TAM.
152MM
6,0"

Cartela - Roldana Embutir Tr. 86204 - CT

ACABAMENTO	REF.	MATERIAL
CT-Bicromatizado	86204	Zamac



EMB. INDIV.	5
EMB. COLET.	5

CÓDIGO
067892

Cartela - Tarjeta Fio Redondo 38mm - ZI

ACABAMENTO	REF.	MATERIAL
ZI- Zincado	81098	Aço



EMB. INDIV.	5
EMB. COLET.	5

CÓDIGO
067922

TAM.
38MM
1,5"

Cartela - Tarjeta Fio Redondo 51mm - ZI

ACABAMENTO	REF.	MATERIAL
ZI- Zincado	81098	Aço



EMB. INDIV.	5
EMB. COLET.	5

CÓDIGO
067939

TAM.
51MM
2,0"

Cartela - Tarjeta Fio Redondo 63mm - ZI

ACABAMENTO	REF.	MATERIAL
ZI- Zincado	81098	Aço



EMB. INDIV.	5
EMB. COLET.	5

CÓDIGO
067946

TAM.
63MM
2,5"

Cartela - Tarjeta Fio Redondo 76mm - ZI

ACABAMENTO	REF.	MATERIAL
ZI- Zincado	81098	Aço



EMB. INDIV.	5
EMB. COLET.	5

CÓDIGO
067953

TAM.
76MM
3,0"

Cartela - Tranqueta 86108/2 - ZI

ACABAMENTO	REF.	MATERIAL
ZI- Zincado	86108/2	Zamac



EMB. INDIV.	5
EMB. COLET.	5

CÓDIGO
067977

Cartela - Tranqueta 86108/2 - ZLO

ACABAMENTO	REF.	MATERIAL
ZLO- Zamac Latão Oxi.	86108/2	Zamac



EMB. INDIV.	5
EMB. COLET.	5

CÓDIGO
067960

Cartela - Tranqueta 86108/2 - PF

ACABAMENTO	REF.	MATERIAL
PF- Preto Fosco	86108/2	Zamac



EMB. INDIV.	5
EMB. COLET.	5

CÓDIGO
070298

Cartela - Tranqueta 86108/2 - BC

ACABAMENTO	REF.	MATERIAL
BC- Branco	86108/2	Zamac



EMB. INDIV.	5
EMB. COLET.	5

CÓDIGO
070489

Cartela - Tranqueta B. Virado 86108/4 - ZI

ACABAMENTO	REF.	MATERIAL
ZI- Zincado	86108/4	Zamac



EMB. INDIV.	5
EMB. COLET.	5

CÓDIGO
071479

Cartela - Tranqueta B. Virado 86108/4 - PF

ACABAMENTO	REF.	MATERIAL
PF- Preto Fosco	86108/4	Zamac



EMB. INDIV.	5
EMB. COLET.	5

CÓDIGO
070328

Cartela - Tranqueta B. Virado 86108/4 - BC

ACABAMENTO	REF.	MATERIAL
BC- Branco	86108/4	Zamac



EMB. INDIV.	5
EMB. COLET.	5

CÓDIGO
070519

Cartela - Fecho Segurança Porta 86572 - CR

ACABAMENTO	REF.	MATERIAL
CR- Cromado	86572	Zamac



EMB. INDIV.	5
EMB. COLET.	5

CÓDIGO
020309

Cartela - Fecho Segurança Porta 86572 - ZLO

ACABAMENTO	REF.	MATERIAL
ZLO- Zamac Latão Oxi.l	86572	Zamac



EMB. INDIV.	5
EMB. COLET.	5

CÓDIGO
035105

Cartela - Fixador de Porta/Piso 86151/3 - ZI

ACABAMENTO	REF.	MATERIAL
ZI- Zincado	86151/3	Aço/Zamac



EMB. INDIV.	5
EMB. COLET.	5

CÓDIGO
020163

Cartela - Fixador de Porta/Piso 86151/3 - ZLO

ACABAMENTO	REF.	MATERIAL
ZLO- Zamac Latão Oxi.l	86151/3	Aço/Zamac



EMB. INDIV.	5
EMB. COLET.	5

CÓDIGO
035129

Cartela - Fixador de P./Rodapé 86151/1 - ZI

ACABAMENTO	REF.	MATERIAL
ZI- Zincado	86151/1	Aço/Zamac



EMB. INDIV.	5
EMB. COLET.	5

CÓDIGO
020149

Cartela - Fixador de P./Rodapé 86151/1 - ZLO

ACABAMENTO	REF.	MATERIAL
ZLO- Zamac Latão Oxi.l	86151/1	Aço/Zamac



EMB. INDIV.	5
EMB. COLET.	5

CÓDIGO
035112

Cartela - Arm. de Rede Chumbar 1374/2 - ZI

ACABAMENTO	REF.	MATERIAL
ZI- Zincado	1374/2	Aço



EMB. INDIV.	5
EMB. COLET.	5

CÓDIGO
019334

Cartela - Arm. de Rede Chumbar 1374/2 - ZP

ACABAMENTO	REF.	MATERIAL
ZP- Zincado Preto	1374/2	Aço



EMB. INDIV.	5
EMB. COLET.	5

CÓDIGO
019341

Cartela - Arm. de Rede Sobrepor 1371 - ZI

ACABAMENTO	REF.	MATERIAL
ZI- Zincado	1371	Aço



EMB. INDIV.	5
EMB. COLET.	5

CÓDIGO
019303

Cartela - Arm. de Rede Sobrepor 1371 - ZP

ACABAMENTO	REF.	MATERIAL
ZP- Zincado Preto	1371	Aço



EMB. INDIV.	5
EMB. COLET.	5

CÓDIGO
019310

Cartela - Arm. de Rede Tipo Batom 1375 - ZI

ACABAMENTO	REF.	MATERIAL
ZI- Zincado	1375	Aço/Zamac



EMB. INDIV.	5
EMB. COLET.	5

CÓDIGO
066819

Cartela - Pux. Armário Aço 86140 - CR

ACABAMENTO	REF.	MATERIAL
CR- Cromado	86140	Zamac



EMB. INDIV.	5
EMB. COLET.	5

CÓDIGO
067885
TAM.
104mm

Cartela - Pux. Armário Aço 86140 - BC

ACABAMENTO	REF.	MATERIAL
BC- Branco	86140	Zamac



EMB. INDIV.	5
EMB. COLET.	5

CÓDIGO
070496
TAM.
104mm

Cartela - Pux. Armário Aço 86140 - PF

ACABAMENTO	REF.	MATERIAL
PF- Preto Fosco	86140	Zamac



EMB. INDIV.	5
EMB. COLET.	5

CÓDIGO
070304
TAM.
104mm

Cartela - Pux. Armário Aço 86140 - AZ

ACABAMENTO	REF.	MATERIAL
AZ- Azul	86140	Zamac



EMB. INDIV.	5
EMB. COLET.	5

CÓDIGO
082246
TAM.
104mm

Cartela - Pux. Armário Aço 86140 - BZ

ACABAMENTO	REF.	MATERIAL
BZ- Bronze	86140	Zamac



EMB. INDIV.	5
EMB. COLET.	5

CÓDIGO
082253
TAM.
104mm

Cartela - Pux. Armário Aço 86140 - FU

ACABAMENTO	REF.	MATERIAL
FU- Fume	86140	Zamac



EMB. INDIV.	5
EMB. COLET.	5

CÓDIGO
082222
TAM.
104mm

Cartela - Pux. Armário Aço 86140 - VM

ACABAMENTO	REF.	MATERIAL
VM- Vermelho	86140	Zamac



EMB. INDIV.	5
EMB. COLET.	5

CÓDIGO
082239
TAM.
104mm

Cartela - Puxador Alça 102mm 86127 - CR

ACABAMENTO	REF.	MATERIAL
CR- Cromado	86127	Zamac



EMB. INDIV.	5
EMB. COLET.	5

CÓDIGO
067823
TAM.
102MM
4,0"

Cartela - Puxador Alça 102mm 86127 - PF

ACABAMENTO	REF.	MATERIAL
PF- Preto Fosco	86127	Zamac



EMB. INDIV.	5
EMB. COLET.	5

CÓDIGO
070311
TAM.
102MM
4,0"

Cartela - Puxador Alça 102mm 86127 - BC

ACABAMENTO	REF.	MATERIAL
BC- Branco	86127	Zamac



EMB. INDIV.	5
EMB. COLET.	5

CÓDIGO
070502
TAM.
102MM
4,0"

Cartela - Puxador Alça 102mm 86127 - AZ

ACABAMENTO	REF.	MATERIAL
AZ- Azul	86127	Zamac



EMB. INDIV.	5
EMB. COLET.	5

CÓDIGO
082369

TAM.
102MM
4,0"

Cartela - Puxador Alça 102mm 86127 - BZ

ACABAMENTO	REF.	MATERIAL
BZ- Bronze	86127	Zamac



EMB. INDIV.	5
EMB. COLET.	5

CÓDIGO
082376

TAM.
102MM
4,0"

Cartela - Puxador Alça 102mm 86127 - FU

ACABAMENTO	REF.	MATERIAL
FU- Fume	86127	Zamac



EMB. INDIV.	5
EMB. COLET.	5

CÓDIGO
082345

TAM.
102MM
4,0"

Cartela - Puxador Alça 102mm 86127 - VM

ACABAMENTO	REF.	MATERIAL
VM- Vermelho	86127	Zamac



EMB. INDIV.	5
EMB. COLET.	5

CÓDIGO
082352

TAM.
102MM
4,0"

Cartela - Puxador Alça 120mm 86127 - CR

ACABAMENTO	REF.	MATERIAL
CR- Cromado	86127	Zamac



EMB. INDIV.	5
EMB. COLET.	5

CÓDIGO
067830

TAM.
120MM
4,7"

Cartela - Puxador Alça 120mm 86127 - BC

ACABAMENTO	REF.	MATERIAL
BC- Branco	86127	Zamac



EMB. INDIV.	5
EMB. COLET.	5

CÓDIGO
070533

TAM.
120MM
4,7"

Cartela - Puxador Alça 120mm 86127 - PF

ACABAMENTO	REF.	MATERIAL
PF- Preto Fosco	86127	Zamac



EMB. INDIV.	5
EMB. COLET.	5

CÓDIGO
070342

TAM.
120MM
4,7"

Cartela - Puxador Alça 120mm 86127 - AZ

ACABAMENTO	REF.	MATERIAL
AZ- Azul	86127	Zamac



EMB. INDIV.	5
EMB. COLET.	5

CÓDIGO
082161

TAM.
120MM
4,7"

Cartela - Puxador Alça 120mm 86127 - BZ

ACABAMENTO	REF.	MATERIAL
BZ- Bronze	86127	Zamac



EMB. INDIV.	5
EMB. COLET.	5

CÓDIGO
082178

TAM.
120MM
4,7"

Cartela - Puxador Alça 120mm 86127 - FU

ACABAMENTO	REF.	MATERIAL
FU- Fume	86127	Zamac



EMB. INDIV.	5
EMB. COLET.	5

CÓDIGO
082147

TAM.
120MM
4,7"

Cartela - Puxador Alça 120mm 86127 - VM

ACABAMENTO	REF.	MATERIAL
VM- Vermelho	86127	Zamac



EMB. INDIV.	5
EMB. COLET.	5

CÓDIGO
082154

TAM.
120MM
4,7"

Cartela - Pux. Botão Concavo 86096/2 - CR

ACABAMENTO	REF.	MATERIAL
CR- Cromado	86096/2	Zamac



EMB. INDIV.	5
EMB. COLET.	5

CÓDIGO
067854

TAM.
25mm

Cartela - Pux. Botão Concavo 86096/2 - ZLO

ACABAMENTO	REF.	MATERIAL
ZLO- Zamac Latão Oxi.	86096/2	Zamac



EMB. INDIV.	5
EMB. COLET.	5

CÓDIGO
067847

TAM.
25mm

Cartela - Pux. Botão Concavo 86096/2 - PF

ACABAMENTO	REF.	MATERIAL
PF- Preto Fosco	86096/2	Zamac



EMB. INDIV.	5
EMB. COLET.	5

CÓDIGO
070205

TAM.
25mm

Cartela - Pux. Botão Concavo 86096/2 - BC

ACABAMENTO	REF.	MATERIAL
BC- Branco	86096/2	Zamac



EMB. INDIV.	5
EMB. COLET.	5

CÓDIGO
070397

TAM.
25mm

Cartela - Pux. Botão Convexo 86097/2 - CR

ACABAMENTO	REF.	MATERIAL
CR- Cromado	86097/2	Zamac



EMB. INDIV.	5
EMB. COLET.	5

CÓDIGO
067878

TAM.
25mm

Cartela - Pux. Botão Convexo 86097/2 - ZLO

ACABAMENTO	REF.	MATERIAL
ZLO- Zamac Latão Oxi.	86097/2	Zamac



EMB. INDIV.	5
EMB. COLET.	5

CÓDIGO
067861

TAM.
25mm

Cartela - Pux. Botão Convexo 86097/2 - PF

ACABAMENTO	REF.	MATERIAL
PF- Preto Fosco	86097/2	Zamac



EMB. INDIV.	5
EMB. COLET.	5

CÓDIGO
070212

TAM.
25mm

Cartela - Pux. Botão Convexo 86097/2 - BC

ACABAMENTO	REF.	MATERIAL
BC- Branco	86097/2	Zamac



EMB. INDIV.	5
EMB. COLET.	5

CÓDIGO
070403

TAM.
25mm

Cartela - Porta Cadeado 51mm 81114 - ZI

ACABAMENTO	REF.	MATERIAL
ZI- Zincado	81114	Aço



EMB. INDIV.	5
EMB. COLET.	5

CÓDIGO
067908

TAM.
51MM
2,0"

Cartela - Porta Cadeado 63mm 81114 - ZI

ACABAMENTO	REF.	MATERIAL
ZI- Zincado	81114	Aço



EMB. INDIV.	5
EMB. COLET.	5

CÓDIGO
067915

TAM.
63MM
2,5"

Cartela - Porta Cadeado 89mm 81114 - ZI

ACABAMENTO	REF.	MATERIAL
ZI- Zincado	81114	Aço



EMB. INDIV.	5
EMB. COLET.	5

CÓDIGO
019709

TAM.
89MM
3,5"

Cartela - Porta Cadeado 114mm 81114 - ZI

ACABAMENTO	REF.	MATERIAL
ZI- Zincado	81114	Aço



EMB. INDIV.	5
EMB. COLET.	5

CÓDIGO
019716

TAM.
114MM
4,5"

Cartela - Porta Cadeado 51mm 81114 - PF

ACABAMENTO	REF.	MATERIAL
PF- Preto Fosco	81114	Aço



EMB. INDIV.	5
EMB. COLET.	5

CÓDIGO
070250

TAM.
51MM
2,0"

Cartela - Porta Cadeado 63mm 81114 - PF

ACABAMENTO	REF.	MATERIAL
PF- Preto Fosco	81114	Aço



EMB. INDIV.	5
EMB. COLET.	5

CÓDIGO
070267

TAM.
63MM
2,5"

Cartela - Porta Cadeado 89mm 81114 - PF

ACABAMENTO	REF.	MATERIAL
PF- Preto Fosco	81114	Aço



EMB. INDIV.	5
EMB. COLET.	5

CÓDIGO
070274

TAM.
89MM
3,5"

Cartela - Porta Cadeado 114mm 81114 - PF

ACABAMENTO	REF.	MATERIAL
PF- Preto Fosco	81114	Aço



EMB. INDIV.	5
EMB. COLET.	5

CÓDIGO
070281

TAM.
114MM
4,5"

Cartela - Porta Cadeado 51mm 81114 - BC

ACABAMENTO	REF.	MATERIAL
BC- Branco	81114	Aço



EMB. INDIV.	5
EMB. COLET.	5

CÓDIGO
070441

TAM.
51MM
2,0"

Cartela - Porta Cadeado 63mm 81114 - BC

ACABAMENTO	REF.	MATERIAL
BC- Branco	81114	Aço



EMB. INDIV.	5
EMB. COLET.	5

CÓDIGO
070458

TAM.
63MM
2,5"

Cartela - Porta Cadeado 89mm 81114 - BC

ACABAMENTO	REF.	MATERIAL
BC- Branco	81114	Aço



EMB. INDIV.	5
EMB. COLET.	5

CÓDIGO
070465

TAM.
89MM
3,5"

Cartela - Porta Cadeado 114mm 81114 - BC

ACABAMENTO	REF.	MATERIAL
BC- Branco	81114	Aço



EMB. INDIV.	5
EMB. COLET.	5

CÓDIGO
070472

TAM.
114MM
4,5"

Cartela - Cabide Simp.Gancho Pequeno 6398/1

ACABAMENTO	REF.	MATERIAL
Zl- Zincado	6398/1	Zamac



EMB. INDIV.	5
EMB. COLET.	5

CÓDIGO
067984

Cartela - Cabide Simp.Gancho Pequeno

ACABAMENTO	REF.	MATERIAL
BC- Branco	6398/1	Zamac



EMB. INDIV.	5
EMB. COLET.	5

CÓDIGO
070410

Cartela - Cabide Simp.Gancho P 6398/1 - PF

ACABAMENTO	REF.	MATERIAL
PF- Preto Fosco	6398/1	Zamac



EMB. INDIV.	5
EMB. COLET.	5

CÓDIGO
070229

Cartela - Cabide Simp.Gancho P 6398/1 - AZ

ACABAMENTO	REF.	MATERIAL
AZ- Azul	6398/1	Zamac



EMB. INDIV.	5
EMB. COLET.	5

CÓDIGO
082208

Cartela - Cabide Simp.Gancho P 6398/1 - BZ

ACABAMENTO	REF.	MATERIAL
BZ- Bronze	6398/1	Zamac



EMB. INDIV.	5
EMB. COLET.	5

CÓDIGO
082215

Ferragens

Cartela - Cabide Simp.Gancho P 6398/1 - FU Cartela - Cabide Simp.Gancho P 6398/1 - VM

ACABAMENTO	REF.	MATERIAL
FU- Fume	6398/1	Zamac



EMB. INDIV.	5
EMB. COLET.	5

CÓDIGO
082185

ACABAMENTO	REF.	MATERIAL
VM- Vermelho	6398/1	Zamac



EMB. INDIV.	5
EMB. COLET.	5

CÓDIGO
082192

Cartela - Cabide Simp.Gancho Grande 6398/3

ACABAMENTO	REF.	MATERIAL
ZI- Zincado	6398/3	Zamac



EMB. INDIV.	5
EMB. COLET.	5

CÓDIGO
067991

Cartela - Cabide Simp.Gancho G 6398/3 - BC

ACABAMENTO	REF.	MATERIAL
BC- Branco	6398/3	Zamac



EMB. INDIV.	5
EMB. COLET.	5

CÓDIGO
070427

Cartela - Cabide Simp.Gancho G 6398/3 - PF

ACABAMENTO	REF.	MATERIAL
PF- Preto Fosco	6398/3	Zamac



EMB. INDIV.	5
EMB. COLET.	5

CÓDIGO
070236

Cartela - Cabide Simp.Gancho G 6398/3 - AZ

ACABAMENTO	REF.	MATERIAL
AZ- Azul	6398/3	Zamac



EMB. INDIV.	5
EMB. COLET.	5

CÓDIGO
082284

Cartela - Cabide Simp.Gancho G 6398/3 - BZ

ACABAMENTO	REF.	MATERIAL
BZ- Bronze	6398/3	Zamac



EMB. INDIV.	5
EMB. COLET.	5

CÓDIGO
082291

Cartela - Cabide Simp.Gancho G 6398/3 - FU

ACABAMENTO	REF.	MATERIAL
FU- Fume	6398/3	Zamac



EMB. INDIV.	5
EMB. COLET.	5

CÓDIGO
082260

Cartela - Cabide Simp.Gancho G 6398/3 - VM

ACABAMENTO	REF.	MATERIAL
VM- Vermelho	6398/3	Zamac



EMB. INDIV.	5
EMB. COLET.	5

CÓDIGO
082277

Cartela - Cabide Duplo Ganc. G 6398/5 - ZI

ACABAMENTO	REF.	MATERIAL
ZI- Zincado	6398/5	Zamac



EMB. INDIV.	5
EMB. COLET.	5

CÓDIGO
068004

Cartela - Cabide Duplo Ganc. G 6398/5 - BC

ACABAMENTO	REF.	MATERIAL
BC- Branco	6398/5	Zamac



EMB. INDIV.	5
EMB. COLET.	5

CÓDIGO
070434

Cartela - Cabide Duplo Ganc. G 6398/5 - PF

ACABAMENTO	REF.	MATERIAL
PF- Preto Fosco	6398/5	Zamac



EMB. INDIV.	5
EMB. COLET.	5

CÓDIGO
070243

Ferragens

Cartela - Cabide Duplo Ganc. G 6398/5 - AZ

ACABAMENTO	REF.	MATERIAL
AZ- Azul	6398/5	Zamac



EMB. INDIV.	5
EMB. COLET.	5

CÓDIGO
082321

Cartela - Cabide Duplo Ganc. G 6398/5 - BZ

ACABAMENTO	REF.	MATERIAL
BZ- Bronze	6398/5	Zamac



EMB. INDIV.	5
EMB. COLET.	5

CÓDIGO
082338

Cartela - Cabide Duplo Ganc. G 6398/5 - FU

ACABAMENTO	REF.	MATERIAL
FU- Fume	6398/5	Zamac



EMB. INDIV.	5
EMB. COLET.	5

CÓDIGO
082307

Cartela - Cabide Duplo Ganc. Grande 6398/5

ACABAMENTO	REF.	MATERIAL
VM- Vermelho	6398/5	Zamac



EMB. INDIV.	5
EMB. COLET.	5

CÓDIGO
082314

Encartelados

Imagens meramente ilustrativas

Rodízios

Rodízios Mesa Giratório 5629ME12

ACABAMENTO	REF.	MATERIAL
ZI- ZINCADO	5629ME12	POLIETILENO

EMB. INDIV.	28
EMB. COLET.	28

CÓDIGO
017743

CARGA 25 KG



Rodízios Mesa Giratório 7629ME13

ACABAMENTO	REF.	MATERIAL
ZI- ZINCADO	7629ME13	POLIETILENO

EMB. INDIV.	24
EMB. COLET.	24

CÓDIGO
017781

CARGA 45 KG



Rodízios Mesa Giratório 9709ME15

ACABAMENTO	REF.	MATERIAL
ZI- ZINCADO	9709ME15	POLIETILENO

EMB. INDIV.	24
EMB. COLET.	24

CÓDIGO
017934

CARGA 100 KG



Rodízios Mesa Giratório 5629ME12

ACABAMENTO	REF.	MATERIAL
ZI- ZINCADO	5629ME12	POLIETILENO

EMB. INDIV.	5
EMB. COLET.	5

CÓDIGO
068080

CARGA 25 KG



Rodízios Mesa Giratório 7629ME13

ACABAMENTO	REF.	MATERIAL
ZI- ZINCADO	7629ME13	POLIETILENO

EMB. INDIV.	5
EMB. COLET.	5

CÓDIGO
068097

CARGA 45 KG



Reguladores para Gás

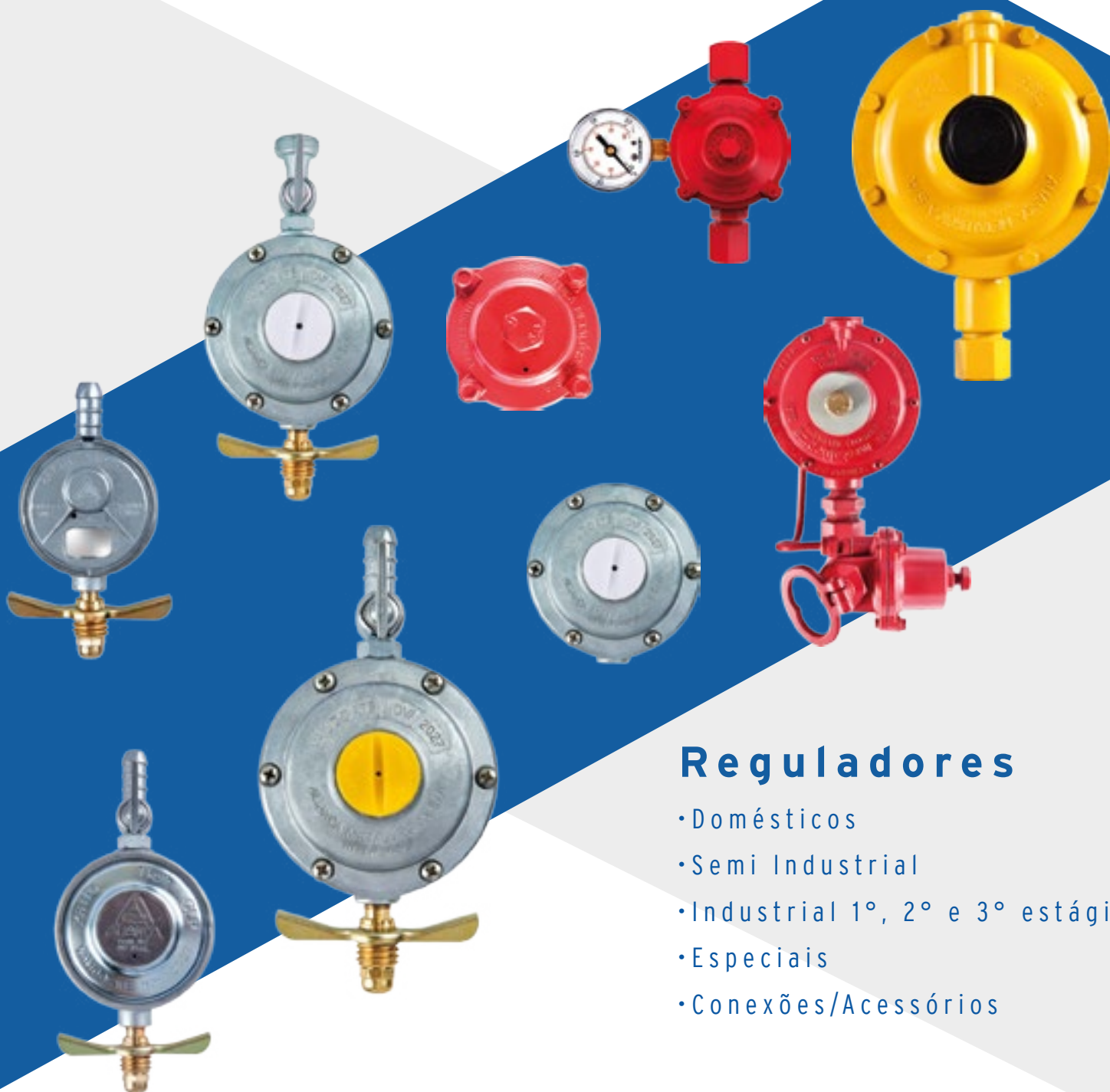

Reguladores

- Domésticos
- Semi Industrial
- Industrial 1º, 2º e 3º estágio
- Especiais
- Conexões/Acessórios

FICHAS TÉCNICAS REGULADORES PARA GÁS

Utilize o leitor de QR Code para
acessar as fichas técnicas
o ou **CLIQUE AQUI**



Reguladores para gás

504/01 BT

REGULADOR	CONEXÃO	VAZÃO	
504/01 BT	CE: Borboleta P13 - CS: 3/8" BM	1kg/h	
			EMB. INDIV.
			10
			EMB. COLET.
			10
CÓDIGO			058555
MATERIAL			Zamac / Aço Latão
Sem Mangueira			

504/01 BT C/ Mangueira 0,80m

REGULADOR	CONEXÃO	VAZÃO	
504/01 BT	CE: Borboleta P13 - CS: 3/8" BM	1kg/h	
			EMB. INDIV.
			10
			EMB. COLET.
			10
CÓDIGO			059514
MATERIAL			Zamac / Aço Latão
Com Mangueira de 0,80m			

504/01 BT C/ Mangueira 1,20m

REGULADOR	CONEXÃO	VAZÃO	
504/01 BT	CE: Borboleta P13 - CS: 3/8" BM	1kg/h	
			EMB. INDIV.
			10
			EMB. COLET.
			10
CÓDIGO			058968
MATERIAL			Zamac / Aço Latão
Com Mangueira de 1,20m			

504/01 BT C/ Manômetro - Blister

REGULADOR	CONEXÃO	VAZÃO	
504/01 BTM Blister	CE: Borboleta P13 - CS: 3/8" BM	1kg/h	
			EMB. INDIV.
			10
			EMB. COLET.
			10
CÓDIGO			070939
MATERIAL			Zamac / Aço Latão
Com Manômetro			

504/01 BT - Blister

REGULADOR	CONEXÃO	VAZÃO	
504/01 BT Blister	CE: Borboleta P13 - CS: 3/8" BM	1kg/h	
			EMB. INDIV.
			10
			EMB. COLET.
			10
CÓDIGO			066840
MATERIAL			Zamac / Aço Latão
Sem Mangueira			

504/01 BT C/ Mangueira 0,80m - Blister

REGULADOR	CONEXÃO	VAZÃO	
504/01 BT Blister	CE: Borboleta P13 - CS: 3/8" BM	1kg/h	
			EMB. INDIV.
			5
			EMB. COLET.
			5
CÓDIGO			066871
MATERIAL			Zamac / Aço Latão
Com Mangueira de 0,80m			

504/01 BT C/ Mangueira 1,20m - Blister

REGULADOR	CONEXÃO	VAZÃO	
504/01 BT Blister	CE: Borboleta P13 - CS: 3/8" BM	1kg/h	
			EMB. INDIV.
			5
			EMB. COLET.
			5
CÓDIGO			066888
MATERIAL			Zamac / Aço Latão
Com Mangueira de 1,20m			

504/01 BC - Blister

REGULADOR	CONEXÃO	VAZÃO	
504/01 BC Blister	CE: Borboleta P13 - CS: 3/8" BM	1kg/h	
			EMB. INDIV.
			10
			EMB. COLET.
			10
CÓDIGO			070168
MATERIAL			Zamac / Aço Latão
Sem Mangueira			

504/01 BC C/ Mangueira 0,80m - Blister

REGULADOR	CONEXÃO	VAZÃO	
504/01 BC Blister	CE: Borboleta P13 - CS: 3/8" BM	1kg/h	
			EMB. INDIV.
			5
			EMB. COLET.
			5
CÓDIGO			070182
MATERIAL			Zamac / Aço Latão
Com Mangueira de 0,80m			

504/01 BC C/ Mangueira 1,20m - Blister

REGULADOR	CONEXÃO	VAZÃO	
504/01 BC Blister	CE: Borboleta P13 - CS: 3/8" BM	1kg/h	
			EMB. INDIV.
			5
			EMB. COLET.
			5
CÓDIGO			070175
MATERIAL			Zamac / Aço Latão
Com Mangueira de 1,20m			

504/01 BC C/ Manômetro - Blister

REGULADOR	CONEXÃO	VAZÃO	
504/01 BCM Blister	CE: Borboleta P13 - CS: 3/8" BM	1kg/h	
			EMB. INDIV.
			10
			EMB. COLET.
			10
CÓDIGO			071509
MATERIAL			Zamac / Aço Latão
Com Manômetro			

505/01 BT

REGULADOR	CONEXÃO	VAZÃO	
505/01 BT	CE: Borboleta P13 - CS: 3/8" BM	1kg/h	
			EMB. INDIV.
			10
			EMB. COLET.
			10
CÓDIGO			061166
MATERIAL			Zamac / Aço Latão
Sem Mangueira			

Reguladores para gás

505/01 BT C/ Mangueira 0,80m

REGULADOR	CONEXÃO	VAZÃO
505/01 BT	CE: Borboleta P13 - CS: 3/8" BM	1kg/h
		
CÓDIGO 061777		
MATERIAL Zamac / Aço Latão		
Com Mangueira de 0,80m		

505/01 BT C/ Mangueira 1,20m

REGULADOR	CONEXÃO	VAZÃO
505/01 BT	CE: Borboleta P13 - CS: 3/8" BM	1kg/h
		
CÓDIGO 061784		
MATERIAL Zamac / Aço Latão		
Com Mangueira de 1,20m		

505/01 BTM C/ Manômetro - Blister

REGULADOR	CONEXÃO	VAZÃO
505/01 BTM Blister	CE: Borboleta P13 - CS: 3/8" BM	1kg/h
		
CÓDIGO 070946		
MATERIAL Zamac / Aço Latão		
Com Manômetro		

505/01 BT - Blister

REGULADOR	CONEXÃO	VAZÃO
505/01 BT Blister	CE: Borboleta P13 - CS: 3/8" BM	1kg/h
		
CÓDIGO 066857		
MATERIAL Zamac / Aço Latão		
Sem Mangueira		

505/01 BT C/ Mangueira 0,80m - Blister

REGULADOR	CONEXÃO	VAZÃO
505/01 BT Blister	CE: Borboleta P13 - CS: 3/8" BM	1kg/h
		
CÓDIGO 066895		
MATERIAL Zamac / Aço Latão		
Com Mangueira de 0,80m		

505/01 BT C/ Mangueira 1,20m - Blister

REGULADOR	CONEXÃO	VAZÃO
505/01 BT Blister	CE: Borboleta P13 - CS: 3/8" BM	1kg/h
		
CÓDIGO 066901		
MATERIAL Zamac / Aço Latão		
Com Mangueira de 1,20m		

506/01 BT

REGULADOR	CONEXÃO	VAZÃO
506/01 BT	CE: Borboleta P13 - CS: 3/8" BM	2kg/h
		
CÓDIGO 054328		
MATERIAL Zamac / Latão Alumínio		
Sem Mangueira		

506/01 BT C/ Mangueira 0,80m

REGULADOR	CONEXÃO	VAZÃO
506/01 BT	CE: Borboleta P13 - CS: 3/8" BM	2kg/h
		
CÓDIGO 081874		
MATERIAL Zamac / Latão Alumínio		
Com Mangueira de 0,80m		

506/01 BT C/ Mangueira 1,20m

REGULADOR	CONEXÃO	VAZÃO
506/01 BT	CE: Borboleta P13 - CS: 3/8" BM	2kg/h
		
CÓDIGO 081881		
MATERIAL Zamac / Latão Alumínio		
Com Mangueira de 1,20m		

506/01 BT - Blister

REGULADOR	CONEXÃO	VAZÃO
506/01 BT Blister	CE: Borboleta P13 - CS: 3/8" BM	2kg/h
		
CÓDIGO 066864		
MATERIAL Zamac / Latão Alumínio		
Sem Mangueira		

506/01 BTM C/ Manômetro - Blister

REGULADOR	CONEXÃO	VAZÃO
506/01 BTM Blister	CE: Borboleta P13 - CS: 3/8" BM	2kg/h
		
CÓDIGO 072032		
MATERIAL Zamac / Latão Alumínio		
Com Manômetro		

Imagens meramente ilustrativas

Linha Doméstica

Reguladores para gás

503/02 BT

REGULADOR	CONEXÃO	VAZÃO
503/02 BT	CE:1/8"NPT CS:1/4"NPT	1kg/h
		
85 mm		
	EMB. INDIV.	10
	EMB. COLET.	10
	CÓDIGO	058692
	MATERIAL	Aço Zamac
		Sem Mangueira

503/09 BT

REGULADOR	CONEXÃO	VAZÃO
503/09 BT	CE: Borboleta P13 - CS:3/8"SAE	1kg/h
		
161 mm		
	EMB. INDIV.	10
	EMB. COLET.	10
	CÓDIGO	058678
	MATERIAL	Zamac / Aço Latão
		Sem Mangueira

503/10 BT

REGULADOR	CONEXÃO	VAZÃO
503/10 BT	CE: Borboleta P13 - CS:1/2"BSP	1kg/h
		
159 mm		
	EMB. INDIV.	10
	EMB. COLET.	10
	CÓDIGO	058685
	MATERIAL	Zamac / Aço Latão
		Sem Mangueira

503/11 BT

REGULADOR	CONEXÃO	VAZÃO
503/11 BT	CE:1/8"NPT CS:3/8"BM	1kg/h
		
135 mm		
	EMB. INDIV.	10
	EMB. COLET.	10
	CÓDIGO	058708
	MATERIAL	Aço Zamac
		Sem Mangueira

503/10 BT - Blister

REGULADOR	CONEXÃO	VAZÃO
503/10 BT	CE: Borboleta P13 - CS:1/2"BSP	1kg/h
		
	EMB. INDIV.	10
	EMB. COLET.	10
	CÓDIGO	070861
	MATERIAL	Zamac / Aço Latão
		Sem Mangueira

506/09 BT

REGULADOR	CONEXÃO	VAZÃO
506/09 BT	CE: Borboleta P13 - CS:3/8"SAE	2kg/h
		
165 mm		
	EMB. INDIV.	10
	EMB. COLET.	10
	CÓDIGO	058715
	MATERIAL	Zamac / Latão Alumínio
		Sem Mangueira

506/10 BT

REGULADOR	CONEXÃO	VAZÃO
506/10 BT	CE: Borboleta P13 - CS:1/2"BSP	2kg/h
		
165 mm		
	EMB. INDIV.	10
	EMB. COLET.	10
	CÓDIGO	058722
	MATERIAL	Zamac / Latão Alumínio
		Sem Mangueira

506/11 BT

REGULADOR	CONEXÃO	VAZÃO
506/11 BT	CE:1/8"NPT CS:3/8"BM	2kg/h
		
135 mm		
	EMB. INDIV.	10
	EMB. COLET.	10
	CÓDIGO	058739
	MATERIAL	Zamac Alumínio
		Sem Mangueira

506/12 BT

REGULADOR	CONEXÃO	VAZÃO
506/12 BT	CE: borboleta P13 CS:1/4"NPT	2kg/h
		
122 mm		
	EMB. INDIV.	10
	EMB. COLET.	10
	CÓDIGO	058746
	MATERIAL	Zamac / Latão Alumínio
		Sem Mangueira

506/09 BT - Blister

REGULADOR	CONEXÃO	VAZÃO
506/09 BT	CE: Borboleta P13 - CS:3/8"SAE	2Kg/h
		
	EMB. INDIV.	10
	EMB. COLET.	10
	CÓDIGO	070878
	MATERIAL	Zamac / Latão Alumínio
		Sem Mangueira

Reguladores para gás

503/18 BT - 2º Estágio

REGULADOR	CONEXÃO	VAZÃO	
503/18 BT	CE: Borboleta P13 - CS: 3/8"SAE	5kg/h	
			EMB. INDIV.
			10
			EMB. COLET.
			10
CÓDIGO			059477
MATERIAL			Zamac / Latão

Sem Mangueira

506/77 AZ - Único Estágio

REGULADOR	CONEXÃO	VAZÃO	
506/77 AZ	CE: 1/4"NPT CS: 3/8"NPT	7kg/h	
			EMB. INDIV.
			10
			EMB. COLET.
			10
CÓDIGO			070144
MATERIAL			Zamac / Alumínio

Sem Mangueira

506/02 BT - Único Estágio

REGULADOR	CONEXÃO	VAZÃO	
506/02 BT	CE: 1/8"NPT - CS: 1/4"NPT	5kg/h	
			EMB. INDIV.
			10
			EMB. COLET.
			10
CÓDIGO			057800
MATERIAL			Zamac / Alumínio

Sem Mangueira

506/18 BT - 2º Estágio

REGULADOR	CONEXÃO	VAZÃO	
506/18 BT	CE: Borb P13 - CS: 3/8"SAE	5kg/h	
			EMB. INDIV.
			10
			EMB. COLET.
			10
CÓDIGO			057848
MATERIAL			Zamac / Latão / Alumínio

Sem Mangueira

506/38 BT - Único Estágio

REGULADOR	CONEXÃO	VAZÃO	
506/38 BT	CE: Borboleta P13 - CS: 3/8"BM	5kg/h	
			EMB. INDIV.
			10
			EMB. COLET.
			10
CÓDIGO			057855
MATERIAL			Zamac / Latão / Alumínio

Sem Mangueira

506/38 BT Kit P/2 P13

REGULADOR	CONEXÃO	VAZÃO	
506/38 BT	CE: Borboleta P13 - CS: 1/2"BSP	5kg/h	
			EMB. INDIV.
			05
			EMB. COLET.
			05
CÓDIGO			048402
MATERIAL			Zamac / Latão / Alumínio

Mang. Borracha Flexível 3/8 x1/2 "BSP

506/65 BT - 2º Estágio

REGULADOR	CONEXÃO	VAZÃO	
506/65 BT	CE: Borboleta P13 - CS: 1/2"BSP	5kg/h	
			EMB. INDIV.
			10
			EMB. COLET.
			10
CÓDIGO			057862
MATERIAL			Zamac / Latão / Alumínio

Sem Mangueira

506/74 BT - 2º Estágio C/Reg. Rápido

REGULADOR	CONEXÃO	VAZÃO	
506/74 BT	CE: Borboleta P13 - CS: 3/8"SAE	6kg/h	
			EMB. INDIV.
			10
			EMB. COLET.
			10
CÓDIGO			068615
MATERIAL			Zamac / Latão / Alumínio

Sem Mangueira

506/03 AZ - Único Estágio

REGULADOR	CONEXÃO	VAZÃO	
506/03 AZ	CE: 1/8"NPT CS: 3/8"NPT	7kg/h	
			EMB. INDIV.
			10
			EMB. COLET.
			10
CÓDIGO			057817
MATERIAL			Zamac / Alumínio

Sem Mangueira

506/03 AZ - Único Estágio - Blister

REGULADOR	CONEXÃO	VAZÃO	
506/03 AZ	CE: 1/8"NPT CS: 3/8"NPT	7kg/h	
			EMB. INDIV.
			10
			EMB. COLET.
			10
CÓDIGO			070885
MATERIAL			Zamac / Alumínio

Sem Mangueira

506/27 AZ - 2º Estágio

REGULADOR	CONEXÃO	VAZÃO	
506/27 AZ	CE: 1/4"NPT CS: 3/8"NPT	7kg/h	
			EMB. INDIV.
			10
			EMB. COLET.
			10
CÓDIGO			057831
MATERIAL			Zamac / Alumínio

Sem Mangueira

506/73 BT - 2º Estágio

REGULADOR	CONEXÃO	VAZÃO	
506/73 BT	CE: 1/8"NPT CS: 3/8"NPT	7kg/h	
			EMB. INDIV.
			10
			EMB. COLET.
			10
CÓDIGO			068547
MATERIAL			Zamac / Alumínio

Sem Mangueira

Imagens meramente ilustrativas

Linha Semi Industrial

Reguladores para gás

511 AM - Único Estágio

REGULADOR	CONEXÃO	VAZÃO
511 AM	CE 1/2"NPT CS1/2"NPT	12kg/h



131,5 mm

EMB. INDIV.	01
EMB. COLET.	01

CÓDIGO
031978

MATERIAL
Zamac
Alumínio

Sem Acessórios

511/01 LJ - 2º Estágio

REGULADOR	CONEXÃO	VAZÃO
511/01 LJ	CE 1/2"NPT CS1/2"NPT	12kg/h



131,5 mm

EMB. INDIV.	01
EMB. COLET.	01

CÓDIGO
031985

MATERIAL
Zamac
Alumínio

Sem Acessórios

511/04 VD - Único Estágio

REGULADOR	CONEXÃO	VAZÃO
511/04 VD	CE 1/2"NPT CS1/2"NPT	20kg/h



131,5 mm

EMB. INDIV.	01
EMB. COLET.	01

CÓDIGO
045586

MATERIAL
Zamac
Alumínio

Sem Acessórios

511/05 AZ - 2º Estágio

REGULADOR	CONEXÃO	VAZÃO
511/05 AZ	CE 1/2"NPT CS1/2"NPT	20kg/h



131,5 mm

EMB. INDIV.	01
EMB. COLET.	01

CÓDIGO
045593

MATERIAL
Zamac
Alumínio

Sem Acessórios

510 AM - Único Estágio

REGULADOR	CONEXÃO	VAZÃO
510 AM	CE 3/4"NPT CS3/4"NPT	50kg/h



228 mm

EMB. INDIV.	01
EMB. COLET.	01

CÓDIGO
019006

MATERIAL
Alumínio

Sem Acessórios

510/01 LJ - 2º Estágio

REGULADOR	CONEXÃO	VAZÃO
510/01 LJ	CE 3/4"NPT CS3/4"NPT	50kg/h



228 mm

EMB. INDIV.	01
EMB. COLET.	01

CÓDIGO
019013

MATERIAL
Alumínio

Sem Acessórios

511 AM C/ DSA - Único Estágio

REGULADOR	CONEXÃO	VAZÃO
511 AM	CE1/2"NPT- CS:1/2"NPT	12kg/h



226,5 mm

EMB. INDIV.	01
EMB. COLET.	01

CÓDIGO
057695

MATERIAL
Zamac
Alumínio

Acessórios: OPSO

511/01 LJ C/ DSA - 2º Estágio

REGULADOR	CONEXÃO	VAZÃO
511/01 LJ	CE1/2"NPT- CS:1/2"NPT	12kg/h



226,5 mm

EMB. INDIV.	01
EMB. COLET.	01

CÓDIGO
057701

MATERIAL
Zamac
Alumínio

Acessórios: OPSO

511/04 VD C/ DSA - Único Estágio

REGULADOR	CONEXÃO	VAZÃO
511/04 VD	CE1/2"NPT- CS:1/2"NPT	20kg/h



226,5 mm

EMB. INDIV.	01
EMB. COLET.	01

CÓDIGO
057718

MATERIAL
Zamac
Alumínio

Acessórios: OPSO

511/05 AZ C/ DSA - 2º Estágio

REGULADOR	CONEXÃO	VAZÃO
511/05 AZ	CE1/2"NPT- CS:1/2"NPT	20kg/h



226,5 mm

EMB. INDIV.	01
EMB. COLET.	01

CÓDIGO
057725

MATERIAL
Zamac
Alumínio

Acessórios: OPSO

510 AM C/ DSA - Único Estágio

REGULADOR	CONEXÃO	VAZÃO
510/01 AM	CE3/4"NPT- CS:3/4"NPT	50kg/h



323 mm

EMB. INDIV.	01
EMB. COLET.	01

CÓDIGO
057664

MATERIAL
Zamac
Alumínio

Acessórios: OPSO

510/01 LJ C/ DSA - 2º Estágio

REGULADOR	CONEXÃO	VAZÃO
510/01 LJ	CE3/4"NPT- CS:3/4"NPT	50kg/h



323 mm

EMB. INDIV.	01
EMB. COLET.	01

CÓDIGO
057671

MATERIAL
Zamac
Alumínio

Acessórios: OPSO

Reguladores para gás

506/32 VM - Alta Pressão

REGULADOR	CONEXÃO	VAZÃO				
506/32 VM PS:0,7 kgf/cm ² VM	CE: Borboleta P13 - CS:3/8"BM	2kg/h				
						
179 mm						
Sem Mangueira						
<table border="1"> <tr><td>EMB. INDIV.</td></tr> <tr><td>10</td></tr> <tr><td>EMB. COLET.</td></tr> <tr><td>10</td></tr> </table>			EMB. INDIV.	10	EMB. COLET.	10
EMB. INDIV.						
10						
EMB. COLET.						
10						
CÓDIGO 025694						
MATERIAL Zamac / Latão Alumínio						

506/33 VM - Alta Pressão

REGULADOR	CONEXÃO	VAZÃO				
506/33 VM PS:1,5 kgf/cm ²	CE: Borboleta P13 - CS:3/8"BM	2kg/h				
						
179 mm						
Sem Mangueira						
<table border="1"> <tr><td>EMB. INDIV.</td></tr> <tr><td>10</td></tr> <tr><td>EMB. COLET.</td></tr> <tr><td>10</td></tr> </table>			EMB. INDIV.	10	EMB. COLET.	10
EMB. INDIV.						
10						
EMB. COLET.						
10						
CÓDIGO 025724						
MATERIAL Zamac / Latão Alumínio						

506/71 VM - Alta Pressão

REGULADOR	CONEXÃO	VAZÃO				
506/71 VM PS:0,7 kgf/cm ²	CE: Borboleta P13 - CS:5/16"BM	2kg/h				
						
179 mm						
Sem Mangueira						
<table border="1"> <tr><td>EMB. INDIV.</td></tr> <tr><td>10</td></tr> <tr><td>EMB. COLET.</td></tr> <tr><td>10</td></tr> </table>			EMB. INDIV.	10	EMB. COLET.	10
EMB. INDIV.						
10						
EMB. COLET.						
10						
CÓDIGO 067601						
MATERIAL Zamac / Latão Alumínio						

506/72 VM - Alta Pressão

REGULADOR	CONEXÃO	VAZÃO				
506/72 VM PS:1,5 kgf/cm ²	CE: Borboleta P13 - CS:5/16"BM	2kg/h				
						
179 mm						
Sem Mangueira						
<table border="1"> <tr><td>EMB. INDIV.</td></tr> <tr><td>10</td></tr> <tr><td>EMB. COLET.</td></tr> <tr><td>10</td></tr> </table>			EMB. INDIV.	10	EMB. COLET.	10
EMB. INDIV.						
10						
EMB. COLET.						
10						
CÓDIGO 067618						
MATERIAL Zamac / Latão Alumínio						

510/02 VM C/ DSA - 1º Estágio

REGULADOR	CONEXÃO	VAZÃO				
510/02 VM PS:1,5 kgf/cm ²	CE:3/4"NPT- -CS:3/4"NPT	50kg/h				
						
323 mm						
Acessórios: OPSO						
<table border="1"> <tr><td>EMB. INDIV.</td></tr> <tr><td>01</td></tr> <tr><td>EMB. COLET.</td></tr> <tr><td>01</td></tr> </table>			EMB. INDIV.	01	EMB. COLET.	01
EMB. INDIV.						
01						
EMB. COLET.						
01						
CÓDIGO 060879						
MATERIAL Zamac Alumínio						

510/02 VMM C/ DSA MANOM. - 1º Estágio

REGULADOR	CONEXÃO	VAZÃO				
510/02 VMM PS:1,5 kgf/cm ²	CE:3/4"NPT- -CS:3/4"NPT	50kg/h				
						
323 mm						
Acessórios: OPSO Manômetro						
<table border="1"> <tr><td>EMB. INDIV.</td></tr> <tr><td>01</td></tr> <tr><td>EMB. COLET.</td></tr> <tr><td>01</td></tr> </table>			EMB. INDIV.	01	EMB. COLET.	01
EMB. INDIV.						
01						
EMB. COLET.						
01						
CÓDIGO 069704						
MATERIAL Zamac Alumínio						

510/02 VM - 1º Estágio

REGULADOR	CONEXÃO	VAZÃO				
510/02 VM PS:1,5 kgf/cm ²	CE:3/4"NPT- -CS:3/4"NPT	50kg/h				
						
226 mm						
Sem Acessórios						
<table border="1"> <tr><td>EMB. INDIV.</td></tr> <tr><td>01</td></tr> <tr><td>EMB. COLET.</td></tr> <tr><td>01</td></tr> </table>			EMB. INDIV.	01	EMB. COLET.	01
EMB. INDIV.						
01						
EMB. COLET.						
01						
CÓDIGO 019020						
MATERIAL Alumínio						

510/02 VMM - 1º Estágio

REGULADOR	CONEXÃO	VAZÃO				
510/02 VMM PS:1,5 kgf/cm ²	CE:3/4"NPT- -CS:3/4"NPT	50kg/h				
						
228 mm						
Acessórios: OPSO Manômetro						
<table border="1"> <tr><td>EMB. INDIV.</td></tr> <tr><td>01</td></tr> <tr><td>EMB. COLET.</td></tr> <tr><td>01</td></tr> </table>			EMB. INDIV.	01	EMB. COLET.	01
EMB. INDIV.						
01						
EMB. COLET.						
01						
CÓDIGO 039714						
MATERIAL Alumínio						

510/03 VM C/ DSA - 1º Estágio

REGULADOR	CONEXÃO	VAZÃO				
510/03 VM PS:1,5 kgf/cm ²	CE:3/4"NPT- -CS:3/4"NPT	90kg/h				
						
323 mm						
Acessórios: OPSO						
<table border="1"> <tr><td>EMB. INDIV.</td></tr> <tr><td>01</td></tr> <tr><td>EMB. COLET.</td></tr> <tr><td>01</td></tr> </table>			EMB. INDIV.	01	EMB. COLET.	01
EMB. INDIV.						
01						
EMB. COLET.						
01						
CÓDIGO 060886						
MATERIAL Zamac Alumínio						

510/03 VM C/ DSA - 1º Estágio

REGULADOR	CONEXÃO	VAZÃO				
510/03 VM PS:1,5 kgf/cm ²	CE:3/4"NPT- -CS:3/4"NPT	90kg/h				
						
323 mm						
Acessórios: OPSO Manômetro						
<table border="1"> <tr><td>EMB. INDIV.</td></tr> <tr><td>01</td></tr> <tr><td>EMB. COLET.</td></tr> <tr><td>01</td></tr> </table>			EMB. INDIV.	01	EMB. COLET.	01
EMB. INDIV.						
01						
EMB. COLET.						
01						
CÓDIGO 069711						
MATERIAL Zamac Alumínio						

511/02 VM C/ DSA - 1º Estágio

REGULADOR	CONEXÃO	VAZÃO				
511/02 VM PS:1,5 kgf/cm ²	CE:1/2"NPT- -CS:1/2"NPT	15kg/h				
						
226,5 mm						
Acessórios: OPSO						
<table border="1"> <tr><td>EMB. INDIV.</td></tr> <tr><td>01</td></tr> <tr><td>EMB. COLET.</td></tr> <tr><td>01</td></tr> </table>			EMB. INDIV.	01	EMB. COLET.	01
EMB. INDIV.						
01						
EMB. COLET.						
01						
CÓDIGO 060855						
MATERIAL Zamac Alumínio						

511/02 VMM C/ DSA MANOM. - 1º Estágio

REGULADOR	CONEXÃO	VAZÃO				
511/02 VMM PS:1,5 kgf/cm ²	CE:1/2"NPT- -CS:1/2"NPT	15kg/h				
						
226,5 mm						
Acessórios: OPSO Manômetro						
<table border="1"> <tr><td>EMB. INDIV.</td></tr> <tr><td>01</td></tr> <tr><td>EMB. COLET.</td></tr> <tr><td>01</td></tr> </table>			EMB. INDIV.	01	EMB. COLET.	01
EMB. INDIV.						
01						
EMB. COLET.						
01						
CÓDIGO 069681						
MATERIAL Zamac Alumínio						

Imagens meramente ilustrativas

Linha Industrial

Reguladores para gás

511/03 VM C/ DSA - 1º Estágio

REGULADOR	CONEXÃO	VAZÃO				
511/03 VM PS:1,5 kgf/cm ²	CE:1/2"NPT- -CS:1/2"NPT	30kg/h				
						
226,5 mm						
<table border="1"> <tr><td>EMB. INDIV.</td></tr> <tr><td>01</td></tr> <tr><td>EMB. COLET.</td></tr> <tr><td>01</td></tr> </table>			EMB. INDIV.	01	EMB. COLET.	01
EMB. INDIV.						
01						
EMB. COLET.						
01						
CÓDIGO 060862						
MATERIAL Zamac Alumínio						
Acessórios: OPSO						

511/03 VMM C/ DSA MANOM. - 1º Estágio

REGULADOR	CONEXÃO	VAZÃO				
511/03 VM PS:1,5 kgf/cm ²	CE:1/2"NPT- -CS:1/2"NPT	30kg/h				
						
226,5 mm						
<table border="1"> <tr><td>EMB. INDIV.</td></tr> <tr><td>01</td></tr> <tr><td>EMB. COLET.</td></tr> <tr><td>01</td></tr> </table>			EMB. INDIV.	01	EMB. COLET.	01
EMB. INDIV.						
01						
EMB. COLET.						
01						
CÓDIGO 069698						
MATERIAL Zamac Alumínio						
Acessórios: OPSO Manômetro						

512/02 VM C/ DSA - 1º Estágio

REGULADOR	CONEXÃO	VAZÃO				
512/02 VM PS:1,5 kgf/cm ²	CE:1/2"NPT- -CS:1/2"NPT	60kg/h				
						
151 mm						
<table border="1"> <tr><td>EMB. INDIV.</td></tr> <tr><td>01</td></tr> <tr><td>EMB. COLET.</td></tr> <tr><td>01</td></tr> </table>			EMB. INDIV.	01	EMB. COLET.	01
EMB. INDIV.						
01						
EMB. COLET.						
01						
CÓDIGO 070977						
MATERIAL Zamac						
Acessórios: OPSO						

512/02 VMMS C/ DSA - 1º Estágio

REGULADOR	CONEXÃO	VAZÃO				
512/02 VMMS ALTA PRESSÃO	CE:1/2"NPT- -CS:1/2"NPT	60kg/h				
						
151 mm						
<table border="1"> <tr><td>EMB. INDIV.</td></tr> <tr><td>01</td></tr> <tr><td>EMB. COLET.</td></tr> <tr><td>01</td></tr> </table>			EMB. INDIV.	01	EMB. COLET.	01
EMB. INDIV.						
01						
EMB. COLET.						
01						
CÓDIGO 070984						
MATERIAL Zamac						
Acessórios: Manômetro						

501/01 VM - 1º Estágio

REGULADOR	CONEXÃO	VAZÃO				
501/01 VM ALTA PRESSÃO	CE3/8"NPT- -CS:3/8"NPT	9kg/h				
						
85 mm						
<table border="1"> <tr><td>EMB. INDIV.</td></tr> <tr><td>01</td></tr> <tr><td>EMB. COLET.</td></tr> <tr><td>01</td></tr> </table>			EMB. INDIV.	01	EMB. COLET.	01
EMB. INDIV.						
01						
EMB. COLET.						
01						
CÓDIGO 046552						
MATERIAL Zamac						

501/01 VMM MANOM. - 1º Estágio

REGULADOR	CONEXÃO	VAZÃO				
501/01 VMM ALTA PRESSÃO	CE3/8"NPT- -CS:3/8"NPT	9kg/h				
						
85 mm						
<table border="1"> <tr><td>EMB. INDIV.</td></tr> <tr><td>01</td></tr> <tr><td>EMB. COLET.</td></tr> <tr><td>01</td></tr> </table>			EMB. INDIV.	01	EMB. COLET.	01
EMB. INDIV.						
01						
EMB. COLET.						
01						
CÓDIGO 046569						
MATERIAL Zamac						
Acessórios: Manômetro						

501/02 VM - 1º Estágio

REGULADOR	CONEXÃO	VAZÃO				
501/02 VM PS:1,5 kgf/cm ²	CE1/2"NPT- -CS:1/2"NPT	9kg/h				
						
139 mm						
<table border="1"> <tr><td>EMB. INDIV.</td></tr> <tr><td>01</td></tr> <tr><td>EMB. COLET.</td></tr> <tr><td>01</td></tr> </table>			EMB. INDIV.	01	EMB. COLET.	01
EMB. INDIV.						
01						
EMB. COLET.						
01						
CÓDIGO 053871						
MATERIAL Zamac						
Sem Acessórios						

501/02 VMM MANOM. - 1º Estágio

REGULADOR	CONEXÃO	VAZÃO				
501/02 VMM PS:1,5 kgf/cm ²	CE1/2"NPT- -CS:1/2"NPT	9kg/h				
						
139 mm						
<table border="1"> <tr><td>EMB. INDIV.</td></tr> <tr><td>01</td></tr> <tr><td>EMB. COLET.</td></tr> <tr><td>01</td></tr> </table>			EMB. INDIV.	01	EMB. COLET.	01
EMB. INDIV.						
01						
EMB. COLET.						
01						
CÓDIGO 053864						
MATERIAL Zamac						
Acessórios: Manômetro						

510/03 VM - 1º Estágio

REGULADOR	CONEXÃO	VAZÃO				
510/03 VM PS:1,5 kgf/cm ²	CE3/4"NPT- -CS:3/4"NPT	90kg/h				
						
226 mm						
<table border="1"> <tr><td>EMB. INDIV.</td></tr> <tr><td>01</td></tr> <tr><td>EMB. COLET.</td></tr> <tr><td>01</td></tr> </table>			EMB. INDIV.	01	EMB. COLET.	01
EMB. INDIV.						
01						
EMB. COLET.						
01						
CÓDIGO 019037						
MATERIAL Alumínio						
Acessórios: OPSO						

510/03 VMM - 1º Estágio

REGULADOR	CONEXÃO	VAZÃO				
510/03 VMM PS:1,5 kgf/cm ²	CE3/4"NPT- -CS:3/4"NPT	90kg/h				
						
228 mm						
<table border="1"> <tr><td>EMB. INDIV.</td></tr> <tr><td>01</td></tr> <tr><td>EMB. COLET.</td></tr> <tr><td>01</td></tr> </table>			EMB. INDIV.	01	EMB. COLET.	01
EMB. INDIV.						
01						
EMB. COLET.						
01						
CÓDIGO 039721						
MATERIAL Alumínio						
Acessórios: Manômetro						

511/02 VM - 1º Estágio

REGULADOR	CONEXÃO	VAZÃO				
511/02 VM PS:1,5 kgf/cm ²	CE1/2"NPT- -CS:1/2"NPT	15kg/h				
						
131,5 mm						
<table border="1"> <tr><td>EMB. INDIV.</td></tr> <tr><td>01</td></tr> <tr><td>EMB. COLET.</td></tr> <tr><td>01</td></tr> </table>			EMB. INDIV.	01	EMB. COLET.	01
EMB. INDIV.						
01						
EMB. COLET.						
01						
CÓDIGO 039738						
MATERIAL Zamac Alumínio						
Sem Acessórios						

511/02 VMM - C/ MANOM. 1º Estágio

REGULADOR	CONEXÃO	VAZÃO				
511/02 VMM PS:1,5 kgf/cm ²	CE1/2"NPT- -CS:1/2"NPT	15kg/h				
						
131,5 mm						
<table border="1"> <tr><td>EMB. INDIV.</td></tr> <tr><td>01</td></tr> <tr><td>EMB. COLET.</td></tr> <tr><td>01</td></tr> </table>			EMB. INDIV.	01	EMB. COLET.	01
EMB. INDIV.						
01						
EMB. COLET.						
01						
CÓDIGO 039745						
MATERIAL Zamac Alumínio						
Acessórios: Manômetro						

Reguladores para gás

511/03 VM - 1º Estágio

REGULADOR	CONEXÃO	VAZÃO				
511/03 AM PS:1,5 kgf/cm ²	CE1/2"NPT- -CS:1/2"NPT	30kg/h				
						
131,5 mm						
Sem Acessórios						
<table border="1"> <tr><td>EMB. INDIV.</td></tr> <tr><td>01</td></tr> <tr><td>EMB. COLET.</td></tr> <tr><td>01</td></tr> </table>			EMB. INDIV.	01	EMB. COLET.	01
EMB. INDIV.						
01						
EMB. COLET.						
01						
CÓDIGO 039752						
MATERIAL Zamac Alumínio						

511/03 VMM - C/ MANOM. 1º Estágio

REGULADOR	CONEXÃO	VAZÃO				
511/03 VMM PS:1,5 kgf/cm ²	CE1/2"NPT- -CS:1/2"NPT	30kg/h				
						
131,5 mm						
Acessórios: Manômetro						
<table border="1"> <tr><td>EMB. INDIV.</td></tr> <tr><td>01</td></tr> <tr><td>EMB. COLET.</td></tr> <tr><td>01</td></tr> </table>			EMB. INDIV.	01	EMB. COLET.	01
EMB. INDIV.						
01						
EMB. COLET.						
01						
CÓDIGO 039769						
MATERIAL Zamac Alumínio						

512/02 VM - 1º Estágio

REGULADOR	CONEXÃO	VAZÃO				
512/02 VM PS:1,5 kgf/cm ²	CE1/2"NPT- -CS:1/2"NPT	60kg/h				
						
75 mm						
Sem Acessórios						
<table border="1"> <tr><td>EMB. INDIV.</td></tr> <tr><td>01</td></tr> <tr><td>EMB. COLET.</td></tr> <tr><td>01</td></tr> </table>			EMB. INDIV.	01	EMB. COLET.	01
EMB. INDIV.						
01						
EMB. COLET.						
01						
CÓDIGO 068721						
MATERIAL Zamac						

512/02 VMMS - C/ MANOM. 1º Estágio

REGULADOR	CONEXÃO	VAZÃO				
512/02 VMMS PS:1,5 kgf/cm ²	CE1/2"NPT- -CS:1/2"NPT	60kg/h				
						
75 mm						
Acessórios: Manômetro						
<table border="1"> <tr><td>EMB. INDIV.</td></tr> <tr><td>01</td></tr> <tr><td>EMB. COLET.</td></tr> <tr><td>01</td></tr> </table>			EMB. INDIV.	01	EMB. COLET.	01
EMB. INDIV.						
01						
EMB. COLET.						
01						
CÓDIGO 068745						
MATERIAL Zamac						

512/02 VMMS - C/ MANOM. 1º Estágio

REGULADOR	CONEXÃO	VAZÃO				
512/02 VMMS PS:1,5 kgf/cm ²	CE1/2"NPT- -CS:1/2"NPT	60kg/h				
						
75 mm						
Acessórios: Manômetro						
<table border="1"> <tr><td>EMB. INDIV.</td></tr> <tr><td>01</td></tr> <tr><td>EMB. COLET.</td></tr> <tr><td>01</td></tr> </table>			EMB. INDIV.	01	EMB. COLET.	01
EMB. INDIV.						
01						
EMB. COLET.						
01						
CÓDIGO 068769						
MATERIAL Zamac						

512/03 VM - 1º Estágio

REGULADOR	CONEXÃO	VAZÃO				
512/03 VM PS:1,5 kgf/cm ²	CE1/2"NPT- -CS:1/2"NPT	60kg/h				
						
75 mm						
Sem Acessórios						
<table border="1"> <tr><td>EMB. INDIV.</td></tr> <tr><td>01</td></tr> <tr><td>EMB. COLET.</td></tr> <tr><td>01</td></tr> </table>			EMB. INDIV.	01	EMB. COLET.	01
EMB. INDIV.						
01						
EMB. COLET.						
01						
CÓDIGO 078928						
MATERIAL Zamac						

512/03 VMMS - C/ MANOM. 1º Estágio

REGULADOR	CONEXÃO	VAZÃO				
512/03 VMMS PS:1,5 kgf/cm ²	CE1/2"NPT- -CS:1/2"NPT	90kg/h				
						
75 mm						
Acessórios: Manômetro Saída						
<table border="1"> <tr><td>EMB. INDIV.</td></tr> <tr><td>01</td></tr> <tr><td>EMB. COLET.</td></tr> <tr><td>01</td></tr> </table>			EMB. INDIV.	01	EMB. COLET.	01
EMB. INDIV.						
01						
EMB. COLET.						
01						
CÓDIGO 078935						
MATERIAL Zamac						

512/03 VMMS - C/ MANOM. 1º Estágio

REGULADOR	CONEXÃO	VAZÃO				
512/03 VMMS PS:1,5 kgf/cm ²	CE1/2"NPT- -CS:1/2"NPT	90kg/h				
						
75 mm						
Acessórios: Manômetro Saída e Entrada						
<table border="1"> <tr><td>EMB. INDIV.</td></tr> <tr><td>01</td></tr> <tr><td>EMB. COLET.</td></tr> <tr><td>01</td></tr> </table>			EMB. INDIV.	01	EMB. COLET.	01
EMB. INDIV.						
01						
EMB. COLET.						
01						
CÓDIGO 078942						
MATERIAL Zamac						

510 CZ - Especial

REGULADOR	CONEXÃO	VAZÃO				
510 CZ	CE:3/4"NPT- -CS:3/4"NPT	Conforme Especificação				
						
226 mm						
Acessórios: feito sob espec.						
<table border="1"> <tr><td>EMB. INDIV.</td></tr> <tr><td>01</td></tr> <tr><td>EMB. COLET.</td></tr> <tr><td>01</td></tr> </table>			EMB. INDIV.	01	EMB. COLET.	01
EMB. INDIV.						
01						
EMB. COLET.						
01						
CÓDIGO 019068						
MATERIAL Alumínio						

510 CZ C/ DSA - Especial

REGULADOR	CONEXÃO	VAZÃO				
510 CZ	CE3/4"NPT- -CS:3/4"NPT	Conforme Especificação				
						
226,5 mm						
Acessórios: OPSO						
<table border="1"> <tr><td>EMB. INDIV.</td></tr> <tr><td>01</td></tr> <tr><td>EMB. COLET.</td></tr> <tr><td>01</td></tr> </table>			EMB. INDIV.	01	EMB. COLET.	01
EMB. INDIV.						
01						
EMB. COLET.						
01						
CÓDIGO 057688						
MATERIAL Zamac Alumínio						

524/01 BT Estabilizador GN

ESTABILIZADOR	CONEXÃO	VAZÃO				
524/01 BT	CE: 1/2 BSP CS: 1/2 BSP	10m ³ /h GN				
						
73 mm						
Sem Acessórios						
<table border="1"> <tr><td>EMB. INDIV.</td></tr> <tr><td>05</td></tr> <tr><td>EMB. COLET.</td></tr> <tr><td>05</td></tr> </table>			EMB. INDIV.	05	EMB. COLET.	05
EMB. INDIV.						
05						
EMB. COLET.						
05						
CÓDIGO 082949						
MATERIAL Alumínio Latão						

524/02 BT Estabilizador GLP

ESTABILIZADOR	CONEXÃO	VAZÃO				
524/02 BT	CE: 1/2 BSP CS: 1/2 NPT	8kg/h GLP				
						
73 mm						
Sem Acessórios						
<table border="1"> <tr><td>EMB. INDIV.</td></tr> <tr><td>05</td></tr> <tr><td>EMB. COLET.</td></tr> <tr><td>05</td></tr> </table>			EMB. INDIV.	05	EMB. COLET.	05
EMB. INDIV.						
05						
EMB. COLET.						
05						
CÓDIGO 087661						
MATERIAL Alumínio Latão						

Imagens meramente ilustrativas

Linha Industrial

Reguladores para gás

511 CZ - Especial

REGULADOR	CONEXÃO	VAZÃO				
511 CZ	CE: 1/2" NPT - CS: 1/2" NPT	Conforme Especificação				
						
131,5 mm						
Acessórios: feito sob espec.						
<table border="1"> <tr><td>EMB. INDIV.</td></tr> <tr><td>01</td></tr> <tr><td>EMB. COLET.</td></tr> <tr><td>01</td></tr> </table>			EMB. INDIV.	01	EMB. COLET.	01
EMB. INDIV.						
01						
EMB. COLET.						
01						
CÓDIGO 067168						
MATERIAL Zamac Alumínio						

511 CZ C/ DSA - Especial

REGULADOR	CONEXÃO	VAZÃO				
511 CZ	CE: 1/2" NPT - CS: 1/2" NPT	Conforme Especificação				
						
226,5 mm						
Acessórios: OPSO						
<table border="1"> <tr><td>EMB. INDIV.</td></tr> <tr><td>01</td></tr> <tr><td>EMB. COLET.</td></tr> <tr><td>01</td></tr> </table>			EMB. INDIV.	01	EMB. COLET.	01
EMB. INDIV.						
01						
EMB. COLET.						
01						
CÓDIGO 067175						
MATERIAL Zamac Alumínio						

503/00 BT - C/ Registro e Borb. Especial

REGULADOR	CONEXÃO	VAZÃO				
503/00 BT	Conforme Especificação	Conforme Especificação				
						
173 mm						
Acessórios: feito sob espec.						
<table border="1"> <tr><td>EMB. INDIV.</td></tr> <tr><td>25</td></tr> <tr><td>EMB. COLET.</td></tr> <tr><td>25</td></tr> </table>			EMB. INDIV.	25	EMB. COLET.	25
EMB. INDIV.						
25						
EMB. COLET.						
25						
CÓDIGO 071653						
MATERIAL Zamac Latão						

503/00 BT - S/ Conexões Especial

REGULADOR	CONEXÃO	VAZÃO				
503/00 BT	Conforme Especificação	Conforme Especificação				
						
81 mm						
Acessórios: feito sob espec.						
<table border="1"> <tr><td>EMB. INDIV.</td></tr> <tr><td>25</td></tr> <tr><td>EMB. COLET.</td></tr> <tr><td>25</td></tr> </table>			EMB. INDIV.	25	EMB. COLET.	25
EMB. INDIV.						
25						
EMB. COLET.						
25						
CÓDIGO 071660						
MATERIAL Zamac						

506/00 BT - C/ Registro e Borb. Especial

REGULADOR	CONEXÃO	VAZÃO				
506/00 BT	Conforme Especificação	Conforme Especificação				
						
180 mm						
Acessórios: feito sob espec.						
<table border="1"> <tr><td>EMB. INDIV.</td></tr> <tr><td>25</td></tr> <tr><td>EMB. COLET.</td></tr> <tr><td>25</td></tr> </table>			EMB. INDIV.	25	EMB. COLET.	25
EMB. INDIV.						
25						
EMB. COLET.						
25						
CÓDIGO 066024						
MATERIAL Zamac / Latão Alumínio						

506/00 BT - S/ Conexões Especial

REGULADOR	CONEXÃO	VAZÃO				
506/00 BT	Conforme Especificação	Conforme Especificação				
						
85 mm						
Acessórios: feito sob espec.						
<table border="1"> <tr><td>EMB. INDIV.</td></tr> <tr><td>25</td></tr> <tr><td>EMB. COLET.</td></tr> <tr><td>25</td></tr> </table>			EMB. INDIV.	25	EMB. COLET.	25
EMB. INDIV.						
25						
EMB. COLET.						
25						
CÓDIGO 066970						
MATERIAL Zamac Alumínio						

506/68 BT - GN/GLP - 650mmca

REGULADOR	CONEXÃO	VAZÃO				
506/68 BT PS: 650 mmca	CE: BORB P13 - CS 3/8" SAE	5Nm ³ /h-GN OU 5kg/h-GLP				
						
180 mm						
Sem Mangueira						
<table border="1"> <tr><td>EMB. INDIV.</td></tr> <tr><td>10</td></tr> <tr><td>EMB. COLET.</td></tr> <tr><td>10</td></tr> </table>			EMB. INDIV.	10	EMB. COLET.	10
EMB. INDIV.						
10						
EMB. COLET.						
10						
CÓDIGO 065652						
MATERIAL Zamac / Latão Alumínio						

506/70 BT - GN/GLP - 650mmca

REGULADOR	CONEXÃO	VAZÃO				
506/70 BT PS: 650 mmca	CE: BORB P13 - CS 3/8" BM	5Nm ³ /h-GN OU 5kg/h-GLP				
						
180 mm						
Sem Mangueira						
<table border="1"> <tr><td>EMB. INDIV.</td></tr> <tr><td>10</td></tr> <tr><td>EMB. COLET.</td></tr> <tr><td>10</td></tr> </table>			EMB. INDIV.	10	EMB. COLET.	10
EMB. INDIV.						
10						
EMB. COLET.						
10						
CÓDIGO 065669						
MATERIAL Zamac Alumínio						

506/76 BT - GN/GLP - 650mmca

REGULADOR	CONEXÃO	VAZÃO				
506/76 BT	CE: 1/4 NPT - CS 3/8" NPT	6Nm ³ /h 7kg/h-GLP				
						
85 mm						
Sem Mangueira						
<table border="1"> <tr><td>EMB. INDIV.</td></tr> <tr><td>10</td></tr> <tr><td>EMB. COLET.</td></tr> <tr><td>10</td></tr> </table>			EMB. INDIV.	10	EMB. COLET.	10
EMB. INDIV.						
10						
EMB. COLET.						
10						
CÓDIGO 069728						
MATERIAL Zamac Alumínio						

76510/04 VD C/ DSA - GN

REGULADOR	CONEXÃO	VAZÃO				
76510/04 VD	CE: 3/4" NPT - CS: 3/4" NPT	30Nm ³ /h PS: 500 mmca				
						
323 mm						
Acessórios: OPSO						
<table border="1"> <tr><td>EMB. INDIV.</td></tr> <tr><td>01</td></tr> <tr><td>EMB. COLET.</td></tr> <tr><td>01</td></tr> </table>			EMB. INDIV.	01	EMB. COLET.	01
EMB. INDIV.						
01						
EMB. COLET.						
01						
CÓDIGO 060039						
MATERIAL Zamac / Latão Alumínio						

76511/06 CZ C/ DSA - GN

REGULADOR	CONEXÃO	VAZÃO				
76511/06 CZ	CE: 1/2" NPT - CS: 1/2" NPT	15Nm ³ /h PS: 500 mmca				
						
226,5 mm						
Acessórios: OPSO						
<table border="1"> <tr><td>EMB. INDIV.</td></tr> <tr><td>01</td></tr> <tr><td>EMB. COLET.</td></tr> <tr><td>01</td></tr> </table>			EMB. INDIV.	01	EMB. COLET.	01
EMB. INDIV.						
01						
EMB. COLET.						
01						
CÓDIGO 060022						
MATERIAL Zamac Alumínio						

76511/12 MR C/ DSA - GN

REGULADOR	CONEXÃO	VAZÃO				
76511/12 MR	CE: 1/2" NPT - CS: 1/2" NPT	8Nm ³ /h PS: 500 mmca				
						
226,5 mm						
Acessórios: OPSO						
<table border="1"> <tr><td>EMB. INDIV.</td></tr> <tr><td>01</td></tr> <tr><td>EMB. COLET.</td></tr> <tr><td>01</td></tr> </table>			EMB. INDIV.	01	EMB. COLET.	01
EMB. INDIV.						
01						
EMB. COLET.						
01						
CÓDIGO 064853						
MATERIAL Zamac Alumínio						

Reguladores para gás

511/14 BT - GN/GLP - 650mmca

REGULADOR	CONEXÃO	VAZÃO				
511/14 BT PS: 650 mmca	CE: 1/2" NPT - CS 1/2" NPT	12Nm ³ /h-GN OU 13 Kg/h-GLP				
						
131,5 mm						
Sem Acessórios						
<table border="1"> <tr><td>EMB. INDIV.</td></tr> <tr><td>01</td></tr> <tr><td>EMB. COLET.</td></tr> <tr><td>01</td></tr> </table>			EMB. INDIV.	01	EMB. COLET.	01
EMB. INDIV.						
01						
EMB. COLET.						
01						
CÓDIGO 065577						
MATERIAL Zamac Alumínio						

511/14 BT C/ DSA - GN/GLP - 650mmca

REGULADOR	CONEXÃO	VAZÃO				
511/14 BT PS: 650 mmca	CE: 1/2" NPT - CS 1/2" NPT	12Nm ³ /h-GN OU 13 Kg/h-GLP				
						
226,5 mm						
Acessórios: OPSO						
<table border="1"> <tr><td>EMB. INDIV.</td></tr> <tr><td>01</td></tr> <tr><td>EMB. COLET.</td></tr> <tr><td>01</td></tr> </table>			EMB. INDIV.	01	EMB. COLET.	01
EMB. INDIV.						
01						
EMB. COLET.						
01						
CÓDIGO 065584						
MATERIAL Zamac Alumínio						

511/15 BT - GN/GLP - 650mmca

REGULADOR	CONEXÃO	VAZÃO				
511/15 BT PS: 650 mmca	CE: 1/2" NPT - CS 1/2" NPT	20Nm ³ /h-GN OU 22 Kg/h-GLP				
						
131,5 mm						
Sem Acessórios						
<table border="1"> <tr><td>EMB. INDIV.</td></tr> <tr><td>01</td></tr> <tr><td>EMB. COLET.</td></tr> <tr><td>01</td></tr> </table>			EMB. INDIV.	01	EMB. COLET.	01
EMB. INDIV.						
01						
EMB. COLET.						
01						
CÓDIGO 065591						
MATERIAL Zamac Alumínio						

511/15 BT C/ DSA - GN/GLP - 650mmca

REGULADOR	CONEXÃO	VAZÃO				
511/15 BT PS: 650 mmca	CE: 1/2" NPT - CS 1/2" NPT	20Nm ³ /h-GN OU 22 Kg/h-GLP				
						
226,5 mm						
Acessórios: OPSO						
<table border="1"> <tr><td>EMB. INDIV.</td></tr> <tr><td>01</td></tr> <tr><td>EMB. COLET.</td></tr> <tr><td>01</td></tr> </table>			EMB. INDIV.	01	EMB. COLET.	01
EMB. INDIV.						
01						
EMB. COLET.						
01						
CÓDIGO 065607						
MATERIAL Zamac Alumínio						

510/07 BT C/ DSA - GN/GLP - 650mmca

REGULADOR	CONEXÃO	VAZÃO				
510/07 BT PS: 650 mmca	CE: 3/4" NPT - CS 3/4" NPT	40Nm ³ /h-GN OU 50 Kg/h-GLP				
						
323 mm						
Sem OPSO						
<table border="1"> <tr><td>EMB. INDIV.</td></tr> <tr><td>01</td></tr> <tr><td>EMB. COLET.</td></tr> <tr><td>01</td></tr> </table>			EMB. INDIV.	01	EMB. COLET.	01
EMB. INDIV.						
01						
EMB. COLET.						
01						
CÓDIGO 065621						
MATERIAL Zamac Alumínio						

510/07 BT - GN/GLP - 650mmca

REGULADOR	CONEXÃO	VAZÃO				
510/07	CE: 3/4" NPT - CS: 3/4" NPT	40Nm ³ /h PS:200 mmca				
						
226,5 mm						
Sem Acessórios						
<table border="1"> <tr><td>EMB. INDIV.</td></tr> <tr><td>01</td></tr> <tr><td>EMB. COLET.</td></tr> <tr><td>01</td></tr> </table>			EMB. INDIV.	01	EMB. COLET.	01
EMB. INDIV.						
01						
EMB. COLET.						
01						
CÓDIGO 065614						
MATERIAL Zamac Alumínio						

506/75 BT - Gás Natural

REGULADOR	CONEXÃO	VAZÃO				
506/75 BT	CE: 1/4" NPT - CS: 3/8" NPT	4Nm ³ /h PS:220 mmca				
						
85 mm						
Sem Mangueira						
<table border="1"> <tr><td>EMB. INDIV.</td></tr> <tr><td>10</td></tr> <tr><td>EMB. COLET.</td></tr> <tr><td>10</td></tr> </table>			EMB. INDIV.	10	EMB. COLET.	10
EMB. INDIV.						
10						
EMB. COLET.						
10						
CÓDIGO 069049						
MATERIAL Zamac Alumínio						

511/13 MR C/ DSA - Gás Natural

REGULADOR	CONEXÃO	VAZÃO				
511/13 MR	CE: 1/2" NPT - CS: 1/2" NPT	8Nm ³ /h PS:200 mmca				
						
226,5 mm						
Acessórios: OPSO						
<table border="1"> <tr><td>EMB. INDIV.</td></tr> <tr><td>01</td></tr> <tr><td>EMB. COLET.</td></tr> <tr><td>01</td></tr> </table>			EMB. INDIV.	01	EMB. COLET.	01
EMB. INDIV.						
01						
EMB. COLET.						
01						
CÓDIGO 064860						
MATERIAL Zamac Alumínio						

511/07 AZ - Gás Natural

REGULADOR	CONEXÃO	VAZÃO				
511/07 AZ	CE: 1/2" NPT CS: 1/2" NPT	15Nm ³ /h PS:200 mmca				
						
131,5 mm						
Sem Acessórios						
<table border="1"> <tr><td>EMB. INDIV.</td></tr> <tr><td>01</td></tr> <tr><td>EMB. COLET.</td></tr> <tr><td>01</td></tr> </table>			EMB. INDIV.	01	EMB. COLET.	01
EMB. INDIV.						
01						
EMB. COLET.						
01						
CÓDIGO 069032						
MATERIAL Zamac Alumínio						

511/07 AZ C/ DSA - Gás Natural

REGULADOR	CONEXÃO	VAZÃO				
511/07 AZ	CE: 1/2" NPT - CS: 1/2" NPT	15Nm ³ /h PS:200 mmca				
						
226,5 mm						
Acessórios: OPSO						
<table border="1"> <tr><td>EMB. INDIV.</td></tr> <tr><td>01</td></tr> <tr><td>EMB. COLET.</td></tr> <tr><td>01</td></tr> </table>			EMB. INDIV.	01	EMB. COLET.	01
EMB. INDIV.						
01						
EMB. COLET.						
01						
CÓDIGO 060800						
MATERIAL Zamac Alumínio						

510/05 AZ - Gás Natural

REGULADOR	CONEXÃO	VAZÃO				
510/05 AZ	CE: 3/4" NPT - CS: 3/4" NPT	30Nm ³ /h PS:200 mmca				
						
226 mm						
Acessórios: OPSO						
<table border="1"> <tr><td>EMB. INDIV.</td></tr> <tr><td>01</td></tr> <tr><td>EMB. COLET.</td></tr> <tr><td>01</td></tr> </table>			EMB. INDIV.	01	EMB. COLET.	01
EMB. INDIV.						
01						
EMB. COLET.						
01						
CÓDIGO 069025						
MATERIAL Zamac Alumínio						

510/05 AZ C/ DSA - Gás Natural

REGULADOR	CONEXÃO	VAZÃO				
510/05 AZ	CE: 3/4" NPT - CS: 3/4" NPT	30Nm ³ /h PS:200 mmca				
						
323 mm						
Acessórios: OPSO						
<table border="1"> <tr><td>EMB. INDIV.</td></tr> <tr><td>01</td></tr> <tr><td>EMB. COLET.</td></tr> <tr><td>01</td></tr> </table>			EMB. INDIV.	01	EMB. COLET.	01
EMB. INDIV.						
01						
EMB. COLET.						
01						
CÓDIGO 060794						
MATERIAL Zamac Alumínio						

Imagens meramente ilustrativas

Linha Industrial

514/13 BT - Borboleta de Aço

ACESSÓRIO	CONEXÃO
514/13 BT	CE: BORB P13 - CS: 1/8" NPT



71 mm

35 mm

EMB. INDIV.	15
EMB. COLET.	15

CÓDIGO
027841

MATERIAL
Aço / Latão

Acessórios: Borboleta

513 - PVC Mangueira para Gás 0,80m

ACESSÓRIO
513 PVC



EMB. INDIV.	10
EMB. COLET.	10

CÓDIGO
030100

MATERIAL
PVC

Acessórios: Mangueira de PVC

513 - PVC Mangueira para Gás 1,20m

ACESSÓRIO
513 PVC



EMB. INDIV.	10
EMB. COLET.	10

CÓDIGO
047078

MATERIAL
PVC

Acessórios: Mangueira de PVC

517 BT - Registro 1/4X3/8 BM

ACESSÓRIO	CONEXÃO
517 BT	CE: 1/4" NPT CS: 3/8" BM



55 mm

EMB. INDIV.	20
EMB. COLET.	20

CÓDIGO
023935

MATERIAL
Zamac

Acessórios: Registro

517/1 BT - Registro 1/4X3/8 SAE

ACESSÓRIO	CONEXÃO
517/1 BT	CE: 1/4" NPT CS: 3/8" SAE



50 mm

EMB. INDIV.	20
EMB. COLET.	20

CÓDIGO
023942

MATERIAL
Zamac

Acessórios: Registro

517/2 BT - Registro 1/4X1/2 BSP

ACESSÓRIO	CONEXÃO
517/2 BT	CE: 1/4" NPT CS: 1/2" BSP



50 mm

EMB. INDIV.	20
EMB. COLET.	20

CÓDIGO
023959

MATERIAL
Zamac

Acessórios: Registro

517/6 BT - Registro 1/4X5/16 BM

ACESSÓRIO	CONEXÃO
517/6 BT	CE: 1/4" NPT CS: 5/16" BM



55 mm

EMB. INDIV.	20
EMB. COLET.	20

CÓDIGO
058005

MATERIAL
Zamac

Acessórios: Registro

517/7 BT - Registro 3/8X3/8 SAE

ACESSÓRIO	CONEXÃO
517/7 BT	CE: 3/8" NPT CS: 3/8" SAE



60 mm

EMB. INDIV.	20
EMB. COLET.	20

CÓDIGO
058012

MATERIAL
Zamac

Acessórios: Registro

517/8 BT - Registro 1/4X1/2 SAE

ACESSÓRIO	CONEXÃO
517/8 BT	CE: 3/8" NPT CS: 3/8" SAE



54 mm

EMB. INDIV.	20
EMB. COLET.	20

CÓDIGO
058029

MATERIAL
Zamac

Acessórios: Registro

517/9 BT - Registro 3/8X1/2 BSP

ACESSÓRIO	CONEXÃO
517/9 BT	CE: 3/8" NPT CS: 1/2" BSP



54 mm

EMB. INDIV.	20
EMB. COLET.	20

CÓDIGO
058036

MATERIAL
Zamac

Acessórios: Registro

Válvulas de Esfera para Gás

550/1 - Válvula de Esfera Reto

REF.	CONEXÃO
550/1	1/2" NPT

EMB. INDIV.	12
EMB. COLET.	12



CÓDIGO
087906

MATERIAL
LATÃO

Passagem Reduzida
Fêmea X Fêmea Haste Longa

550/2 - Válvula de Esfera Reto

REF.	CONEXÃO
550/2	3/4" NPT

EMB. INDIV.	09
EMB. COLET.	09



CÓDIGO
087913

MATERIAL
LATÃO

Passagem Reduzida
Fêmea X Fêmea Haste Longa

550/3 - Válvula de Esfera Reto

REF.	CONEXÃO
550/3	1" NPT

EMB. INDIV.	08
EMB. COLET.	08



CÓDIGO
087920

MATERIAL
LATÃO

Passagem Reduzida
Fêmea X Fêmea Haste Longa

550/4 - Válvula de Esfera Reto

REF.	CONEXÃO
550/4	1/2" NPT

EMB. INDIV.	13
EMB. COLET.	13



CÓDIGO
087937

MATERIAL
LATÃO

Fêmea X Fêmea Borboleta

550/5 - Válvula de Esfera Reto

REF.	CONEXÃO
550/5	3/4" NPT

EMB. INDIV.	01
EMB. COLET.	10



CÓDIGO
087944

MATERIAL
LATÃO

Fêmea X Fêmea Borboleta

550/6 - Válvula de Esfera Reto

REF.	CONEXÃO
550/6	1" NPT

EMB. INDIV.	06
EMB. COLET.	06



CÓDIGO
087951

MATERIAL
LATÃO

Passagem Reduzida
Fêmea X Fêmea Borboleta

550/7 - Válvula de Esfera Reto

REF.	CONEXÃO
550/07	1/2" NPT

EMB. INDIV.	12
EMB. COLET.	12



CÓDIGO
087968

MATERIAL
LATÃO

Passagem Reduzida
Macho X Fêmea Haste Longa

550/8 - Válvula de Esfera Reto

REF.	CONEXÃO
550/8	1/2" NPT

EMB. INDIV.	14
EMB. COLET.	14



CÓDIGO
087975

MATERIAL
LATÃO

Passagem Reduzida
Macho X Fêmea Borboleta

550/9 - Válvula de Esfera Algar 90°

REF.	CONEXÃO
550/9	1/2" NPT

EMB. INDIV.	18
EMB. COLET.	18



CÓDIGO
087982

MATERIAL
LATÃO

Passagem Reduzida
Macho X Macho Haste Curta

550/10 - Válvula de Esfera Algar 90°

REF.	CONEXÃO
550/10	1/2" NPT

EMB. INDIV.	09
EMB. COLET.	09



CÓDIGO
087999

MATERIAL
LATÃO

Passagem Reduzida
Macho X BM Haste Curta

550/11 - Válvula de Esfera Reto

REF.	CONEXÃO
550/11	1/2" NPT

EMB. INDIV.	09
EMB. COLET.	09



CÓDIGO
088002

MATERIAL
LATÃO

Passagem Reduzida
Macho X BM Haste Curta

550/12 - Válvula de Esfera Angular

REF.	CONEXÃO
550/12	1/2" NPT

EMB. INDIV.	12
EMB. COLET.	12



CÓDIGO
088019

MATERIAL
LATÃO

Passagem Reduzida
Macho X Fêmea Haste Curta

Válvulas de Esfera para Água

540/1 - Válvula de Esfera para Água

REF.	CONEXÃO
540/1	1/2 BSP

EMB. INDIV.	12
EMB. COLET.	12



CÓDIGO
088026

MATERIAL
LATÃO

Passagem Plena
Fêmea X Fêmea PN25

540/2 - Válvula de Esfera para Água

REF.	CONEXÃO
540/2	3/4 BSP

EMB. INDIV.	12
EMB. COLET.	12



CÓDIGO
088033

MATERIAL
LATÃO

Passagem Plena
Fêmea X Fêmea PN25

540/3 - Válvula de Esfera Reto

REF.	CONEXÃO
540/3	1 BSP

EMB. INDIV.	06
EMB. COLET.	06



CÓDIGO
088040

MATERIAL
LATÃO

Passagem Plena
Fêmea X Fêmea PN25

540/4 - Válvula de Esfera para Água

REF.	CONEXÃO
540/4	1 1/4 BSP

EMB. INDIV.	04
EMB. COLET.	04



CÓDIGO
088057

MATERIAL
LATÃO

Passagem Plena
Fêmea X Fêmea PN25

540/5 - Válvula de Esfera para Água

REF.	CONEXÃO
540/5	1 1/2 BSP

EMB. INDIV.	02
EMB. COLET.	02



CÓDIGO
088064

MATERIAL
LATÃO

Passagem Plena
Fêmea X Fêmea PN25

540/6 - Válvula de Esfera Reto

REF.	CONEXÃO
540/6	2 BSP

EMB. INDIV.	02
EMB. COLET.	02



CÓDIGO
088071

MATERIAL
LATÃO

Passagem Plena
Fêmea X Fêmea PN25

540/7 - Válvula de Esfera para Água

REF.	CONEXÃO
540/7	2 1/2 BSP

EMB. INDIV.	01
EMB. COLET.	01



CÓDIGO
088088

MATERIAL
LATÃO

Passagem Plena
Fêmea X Fêmea PN25

540/8 - Válvula de Esfera para Água

REF.	CONEXÃO
540/8	3 BSP

EMB. INDIV.	01
EMB. COLET.	01



CÓDIGO
088095

MATERIAL
LATÃO

Passagem Plena
Fêmea X Fêmea PN25

540/9 - Válvula de Esfera para Água

REF.	CONEXÃO
540/9	4 BSP

EMB. INDIV.	01
EMB. COLET.	01



CÓDIGO
088101



MATERIAL
LATÃO





Passagem Plena
Fêmea X Fêmea PN25

Imagens meramente ilustrativas





Válvulas de Esfera para Água

Reguladores para gás

 Cores	AM Amarelo	AZ Azul	CZ Cinza	MR Marrom	 Características	PE Pressão de entrada	PF Pressão de fechamento	CE Conexão de entrada
	VM Vermelho	BT Bruto	LJ Laranja	BC Branco		PS Pressão de saída	GF Grupo de fechamento	CS Conexão de saída

 Pressão	kPa Quilopascal	 Acessórios	BTM Bruto c/ Manômetro	BCM Branco c/ Manômetro		
	bar Quilograma força por cm ²		VMM Vermelho C/ Manômetro	VMMES Vermelho C/ Manômetro na entrada e saída	VMMS Vermelho C/ Manômetro na saída	DSA = OPSO Dispositivo (sobrepresão) de segurança Aliança Over Pressure Shut Off
 Vazão	m³/h Volume por hora de gás natural (GN)	 Tipos de conexão e aplicação	BM Bico Mamadeira para mangueira de PVC	NPT Conexões para instalações	BSP Conexões para instalações ou mangueira flexíveis de malha de aço	SAE Tubo de cobre flexível
	kg/h Massa por hora de gás liquefeito de petróleo (GLP)					

PRINCIPAIS INFORMAÇÕES PARA REGULADORES USO DOMÉSTICO

 Cores	BT Bruto	 Características	CS Conexão de Saída	 Acessórios	BTM Bruto c/ Manômetro
	BC Branco		CE Conexão de Entrada		BCM Branco c/ Manômetro
 Tipos de conexão e aplicação	BM Bico Mamadeira para mangueira de PVC		NPT Conexões para instalações		SAE Tubo de cobre flexível
	BSP Conexões para instalações ou para mangueira flexível de malha de aço				



aliancametalurgica.com.br

V.02 Jun/2023 - Desenvolvido pelo departamento de Marketing Aliança Metalúrgica S.A



WhatsApp: 2951.1500

Rua Freire Bastos, 89 Jaçana
CEP 02261-020 São Paulo - SP

